

Wireless World

RADIO AND ELECTRONICS

SEPTEMBER

1948

38th YEAR OF PUBLICATION

Proprietors : ILIFFE & SONS LTD.
Managing Editor : HUGH S. POCOCK, M.I.B.E.
Editor : H. F. SMITH

Editorial, Advertising and Publishing Offices :
DORSET HOUSE, STAMFORD STREET,
LONDON, S.E.1.

Telephone : Waterlooo 3333 (60 lines).
Telegrams : "Ethaworld, Sedist, London."

PUBLISHED MONTHLY
Price : 1/6

(Publication date 26th of preceding month)
Subscription Rate : 20/- per annum. Home and
Abroad

Branch Offices :
Birmingham : King Edward House, New Street, 2.
Coventry : 8-10, Corporation Street.
Glasgow : 26B, Renfield Street, C.2.
Manchester : 260, Deansgate, 3.

In this Issue

OUR COVER : New O.B. Television Gear (see page 320).

EDITORIAL COMMENT	311
IS DISCRIMINATOR ALIGNMENT SO DIFFICULT? By A. G. Crocker	312
HARBOUR RADAR By R. F. Hansford	317
ELECTRONIC CIRCUITRY By J. McG. Sowerby	321
ELECTRONICS AT HARWELL	323
MANUFACTURERS' PRODUCTS	325
NEGATIVE FEEDBACK CALCULATIONS By E. J. James	326
HIGH-LEVEL DETECTION By W. MacLanachan	330
SERIES CAPACITOR HEATER CIRCUITS By A. W. Stanley	332
SHORT-WAVE CONDITIONS	334
WORLD OF WIRELESS	335
TRANSFORMERLESS TELEVISION RECEIVER	338
FREQUENCY MODULATION By "Cathode Ray"	339
UNBIASED By "Free Grid"	344
LETTERS TO THE EDITOR	345
RANDOM RADIATIONS By "Diallist"	348
RECENT INVENTIONS	350

Sound Recording on Magnetic-Coated Tapes



TYPE TL/7 — a recording and reproducing head from amongst the components shortly to be made separately available for this specific branch of electronics.

Others include Erasing Heads, Combination Heads, Supersonic Oscillator Coils and Drives in addition to the normal range of Transformers, Switches, etc., which have served the industry so well for the past three decades.

Wright & Weaire, Ltd.
138, SLOANE ST. · LONDON · S.W.1
TELEPHONE: SLOANE 2214/5
Factory
"Simonside Works" South Shields,
Co. Durham



Valves and their applications

A High-Voltage A.C. VALVE VOLTMETER using EY51

A diode is frequently used as the detector in a valve voltmeter and has the advantage over a triode detector that the input capacitance will generally be less.

Many low capacitance diodes give a satisfactory performance with input voltages up to 100 volts but for higher voltages it is necessary to precede the diode by a suitable attenuator. In order that the attenuator shall have a flat frequency characteristic, the effect of diode and stray capacitances must be eliminated.

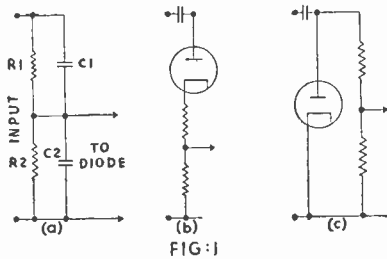

Fig. 1 (a) shows a frequency balanced attenuator in which the component values are related by $\frac{R1}{R2} = \frac{C2}{C1}$ where R2 includes the diode damping resistance and C2 is the parallel combination of diode capacitance and strays; in practice a flat characteristic can be achieved over the audio range but at higher frequencies, diode damping and inductive effects in the components and wiring may give rise to appreciable errors.

For the measurement of high voltages over a wide frequency range it will therefore be preferable to use a high voltage diode such as the EY51 since in this case no input attenuator will be necessary.

A diode voltmeter may use either a series or parallel circuit as shown in Fig 1 (b) and (c); a major disadvantage of the series circuit is that the cathode is at high potential and a heater transformer with high voltage insulation between primary and secondary must be used. Fig. 2 shows a practical parallel circuit in which the cathode is at earth potential.

A balanced metering circuit using an ECC32 double triode has the advantages that drift will be low and a nearly linear voltage scale will result provided the voltage change on the input grid is small (0.75 volt for full scale meter deflection).

The number of resistors and their values in the 12.5 Megohm potentiometer chain P2 will be determined by the number of voltage ranges and their full scale voltages. If

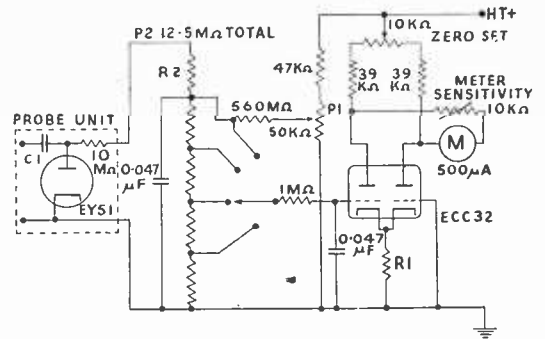

FIG. 2

R2=8 Megohms, the most sensitive voltage range will give full scale deflection for approximately 3 volts input with the component values indicated in the diagram.

P1 serves to balance out the "no-signal" diode current and is a pre-set control which should require readjustment only when the diode is changed.

The value of R1 will depend on the H.T. + voltage and will be of the order of 1000 ohms for a 200 volt D.C. supply.

The lower frequency limit of the voltmeter will be determined by C1 and the higher frequency limit by the resonant frequency of C1 (since every capacitor has associated inductance); the probe construction; or transit time effects in the EY51; for C1=0.02 μF and small stray capacitance in the probe, the error should be less than 3% between 20 c/s and 10 Mc/s.

Satisfactory operation will result with inputs of 1000 volts R.M.S.; C1 must then be able to withstand 3.5 kV.



Reprints of this report from the Mullard Laboratories, together with additional circuit notes, can be obtained free of charge from the address below.

**MULLARD ELECTRONIC PRODUCTS LTD.,
TECHNICAL PUBLICATIONS DEPARTMENT,
CENTURY HOUSE, SHAFESBURY AVE., W.C.2**

(M.V.M.73)

Wireless World

RADIO AND ELECTRONICS

Vol. LIV. No. 9

September 1948

Comments of the Month

THE marine applications of radar are rapidly being extended in a most interesting and promising manner. Apart from the more normal use as a shipborne aid to navigation, shore-based radar is being installed to give aid and guidance to the mariner in several highly specialized circumstances. A station for guiding the Wallasey ferries was installed some time ago, and later equipment was fitted at Douglas, Isle of Man, to help in the handling of exceptional volumes of traffic in bad visibility. In this issue we publish a short description of a more complex system, fitted by the Mersey Harbour Board for the benefit of ships making or leaving the port of Liverpool. Here the designers of the system have had to cope with special difficulties, on account of the length, narrowness and tortuous nature of the entrance channel. Another interesting scheme is also under way: British Railways propose to fit shore-based radar for guiding ferry boats crossing the Thames estuary from Tilbury to Gravesend.

Technically speaking, there seems to be no problem that radar cannot solve at short notice. Its steady growth is much more likely to be slowed down by non-technical considerations, not the least of which is the need for convincing the marine user of the value and reliability of the apparatus.

In the early days there was much distrust of wireless in marine circles, but radar does not seem to suffer from this disadvantage; indeed, potential users are ready to welcome it, provided that it is offered to them in an acceptable form.

A good example of the practical and psychological considerations involved in the planning of shore-based radar systems is afforded by the projected Tilbury-Gravesend scheme. It is understood that the installation is to be operated by masters and mates of the service who, being accustomed to the problems of navigating the estuary, are able to give their colleagues making the crossing the kind of information of which they stand in need when visibility is bad. It is by attention to such factors as these, quite as much as to purely tech-

nical developments, that radar will be made into one of the greatest of modern aids to navigation and pilotage.

Nomenclature

IT is a good sign that the confusing and often illogical jargon of radio seems to be causing, to an increasing extent, searchings of heart among practitioners in the art. In this issue contributors and correspondents touch on various aspects of this subject, in particular on the question of units. We suppose it is inevitable in any quickly developing branch of technology that we should outgrow our system of units: the need for greater and greater multiples or for smaller and smaller sub-multiples constantly makes itself felt, until ultimately a new system, based on convenient quantities, is evolved. And then, presumably, the process repeats itself—that is, unless development comes to a standstill.

Be that as it may, it is hardly reasonable or just to blame those who devised electrical units for failing to provide us with ready-made units convenient for our present-day practice. No one could be expected to have foreseen the directions in which development would proceed. But it is permissible to blame those who take a word of which the meaning is known to all versed in the art and to give it an entirely different meaning. We recently came across an instance where a good deal of confusion was caused by the use—or misuse—of the word "relay." To all wireless men of the older school that expression connotes only one thing: the passing on of a message between two radio stations, out of range of each other, through the intermediary of one or more other stations. By quite legitimate extension, the word was later applied to a station intended solely for the passing-on of messages. It is a great pity that, soon after broadcasting started, the word "relay" was taken into service to describe systems for distributing speech and music at A.F. by wire.

Is Discriminator Alignment

A FREQUENCY - MODULATION receiver differs in two fundamental ways from the more ordinary set designed only for the reception of amplitude - modulated signals. First, the circuits up to and including the demodulator are of greater bandwidth, and secondly, the demodulator itself comprises an amplitude limiter and discriminator. So long as the design parameters are properly chosen, the greater bandwidth of the amplifier stages presents no difficulty; indeed, for equal performance, there are wider tolerances in the F.M. case. Nor does the design of a limiter involve any critical adjustments. Good limiting is readily achieved if the anode and screen volts are kept sufficiently low.

The problem presented by the F.M. receiver centres on the discriminator, its design, alignment and performance. This problem is capable of an orthodox and simple solution, and, as will be shown, need cause no anxiety to the listener or service technician.

The discriminator of the F.M. receiver is of the utmost importance, as performance depends very largely upon it. Its function is to convert the frequency variations of the carrier to ampli-

Facts and Figures on Performance

It has been suggested in this journal that the difficulty of maintaining alignment in receivers for frequency-modulated transmission is likely to prejudice the success of F.M. broadcasting. This article, dealing with methods of alignment and the effects of mis-alignment, reaches the conclusion that, provided the discriminator is suitably designed, serious difficulties are not to be expected.

sion be effected in a linear manner, for if it is not amplitude distortion will be introduced. Non-linearity of the discriminator characteristic causes very similar effects to non-linearity of a valve in an A.M. set.

Without making an exhaustive study of the numerous new circuits which have been suggested in recent years, there are three possible designs to be considered. These are (a) the Amplitude Discriminator with its two secondaries tuned to different frequencies, (b) the Ratio Discriminator which operates as a combined limiter and frequency-to-amplitude converter, and (c) the conventional Phase Discriminator, usually associated with the names of Foster and Seeley. Of these (c) is preferred by the present writer. The Amplitude Dis-

is even more sensitive to misalignment and the half-secondary windings cannot be well balanced for all values of the input voltage. On the other hand, the Phase-Discriminator, if properly designed, is a stable unit in which each variable is under exact control. Only this type will be dealt with in the present article.

Design Parameters.—The frequency deviation (which will be taken as 75 kc/s throughout) and the carrier frequency (taken as 90 Mc/s) determine between them the discriminator design, for the unit must be linear over the whole range of modulation-frequency excursions plus the acceptable tolerance to take account of receiver mistuning and misalignment of the discriminator. Having determined the range over which the latter must be linear,

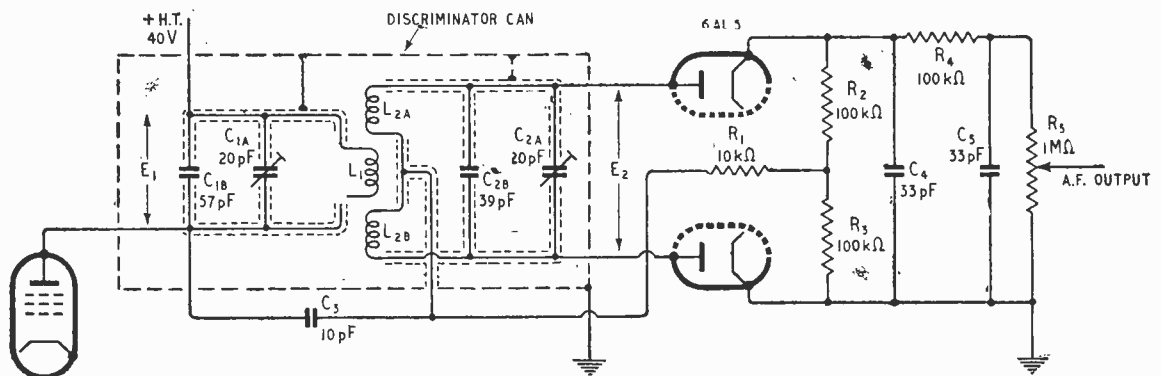

Fig. 1. Circuit diagram of the discriminator and detector showing the screening.

tude changes which subsequent diodes can convert to audio-frequency signals in the usual way. It is highly important that this frequency-to-amplitude conver-

riminator is difficult to align, and linearity over a wide frequency band is hard to achieve. The Ratio Discriminator, which had much publicity in the U.S.A.,

the separation of the peaks may be deduced, and this, in turn, fixes the bandwidth of the I.F. amplifier. There is an optimum centre-frequency for a given gain

So Difficult ?

By A. G. CROCKER (Royal Naval Scientific Service)

over a given band, and so the bandwidth at least suggests the intermediate frequency.

Applying the above considerations to our problem, experience has shown that a tolerance of ± 30 kc/s must be allowed for receiver mistuning at 90 Mc/s under the conditions of broadcast listening. The misalignment of the discriminator will never be greater than ± 20 kc/s at any reasonable intermediate frequency, and so the total tolerances are ± 50 kc/s. Adding this to the modulation bandwidth leads to the result that the discriminator should be linear over a range of ± 125 kc/s. This makes it necessary for the peaks of the discriminator response curve to be separated from the cross-over point by about ± 175 kc/s and therefore the overall I.F. bandwidth must be 250 kc/s. To obtain this bandwidth and this linearity of discriminator characteristic an I.F. at about 15 Mc/s is required. This allows the pass-band to be achieved with discriminator inductances of reasonably high Q . A higher intermediate frequency would introduce the usual difficulties due to stray capacitances and would affect the overall stability. It should be noted in passing that the I.F. bandwidth does not have any direct effect on the signal/noise ratio in a broadcast receiver. The circuit used in the experiments to be described is shown in Fig. 1. It will be treated in more detail later, but it is convenient at this point to enumerate the following characteristics:—

(a) Primary tuning C_{1A} determines the relative amplitude of the two peaks.

(b) Secondary tuning C_{2A} determines the cross-over point.

(c) The coupling factor between primary L_1 and secondaries, L_{2A} , L_{2B} , determines the frequency separation of the two peaks.

(d) Balance of the half-secondaries determines the position of the peaks relative to the cross-over point.

Naturally, these effects are inter-related and successive approximations to the ideal can be made.

Summary of Results.—In order to test the effects of non-linearity and misalignment, and the relation of these to the factors (a), (b), (c) and (d) above, a complete I.F. amplifier with limiter and a discriminator were built according to the preceding specification. Measurements then showed that

at the outset, however, that these test instruments are not necessary for the serviceman, but only for the factory. Since most sweep generators have a sinusoidal sweep, the C.R.O. should have a sinusoidal time base in phase with the sweep so that a linear frequency scale is obtained on the display unit. Otherwise a distorted picture will be obtained even when the discriminator characteristic is linear.

These two instruments are essential for rapid approximate alignment in the factory, but to obtain the maximum linearity in the characteristic the C.R. oscilloscope is inadequate as a test instrument. Static measurements

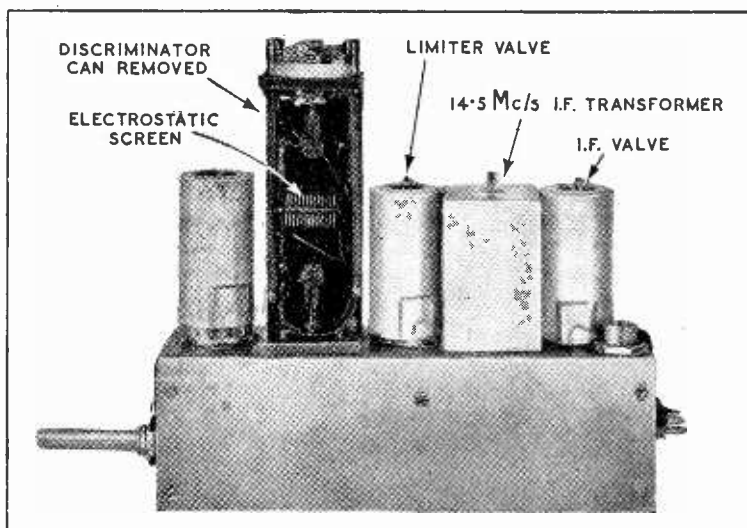

This photograph shows the I.F. unit with the discriminator can removed.

the mid-band frequency was 14.5 Mc/s and the frequency interval between the peaks of the discriminator was 350 kc/s. It was found to be impracticable to carry out the alignment procedure suggested by Sturley,¹ which requires the coupling capacitor C_c to be disconnected while the secondary is being tuned, because its reconnection completely detunes the secondary.

Alignment can be rapidly obtained to a condition approximating to the required characteristic by means of a frequency generator (wobulator) and C.R. oscilloscope. It should be stated

must be taken, using a signal generator with a first-class incremental scale and a valve voltmeter. But, as will be seen, this refinement is fortunately not called for in the broadcast receiver, so long as an overall distortion of 2 per cent can be tolerated.

Having obtained this so-called "approximate" alignment in a manner which is discussed in more detail later, the characteristics were measured, using the best available instruments. The discriminator characteristic is shown in Fig. 2, and it will be noted that the curve is reasonably linear, to ± 125 kc/s, but with visible kinks. For this curve the

¹ The Phase Discriminator, by K. R. Sturley, *Wireless Engineer*, February 1944, Vol. 21, p. 72

Is Discriminator Alignment So Difficult?

distortion of a 1-kc/s note was measured. The results, shown in Table I, include the distortion in the audio source and in the F.M. generator as well as that due to the discriminator. In all cases a 75-kc/s deviation was employed.

Since 2% distortion is approxi-

L_2 was made up of the two separate half-secondaries, placed symmetrically at opposite ends of an axis with the primary at the centre. The mutual-inductance coupling between the two half-secondaries was negligible, so that each coil had an inductance of 1.2 μ H.

As may be seen from Fig. 1, the

the load centre-tap via C_3 too great, and so a resistance of 10 k Ω was inserted between the centre-tap and the capacitor. The effect on the detection efficiency is not serious. The valve used was a 6AL5 double diode and the audio output was taken from the load via a filter network $C_4R_4C_5R_5$ with the values shown in the figure.

Components and Layout.—The most important components are the coils. Air-core coils are too bulky and there are certain mechanical difficulties. Direct winding on individual dust-iron slugs was therefore adopted, the two half-secondaries having threaded brass inserts to allow adjustment of the coupling, which is independent of the primary. Standard G.E.C. Type 81 dust-iron slugs were employed. Approximately 8 turns of No. 30 S.W.G. s.s. enamelled wire were wave-wound and cemented in position with trolitol solution. The measured unloaded Q s were 100 and the inductances were balanced to better than 1%, adjustment being made by moving the wire away from the slug and re-fixing. The arrangement of the coils can be seen in some of the photographs. The overall diameter of each coil was just over $\frac{1}{2}$ in, so the outer metal screen could be made $1\frac{1}{8}$ in wide, $1\frac{1}{2}$ in deep and 3 in high, having negligible effect on the Q s of the coils.

TABLE I

Carrier Frequency (Mc/s) ..	14.425	14.440	14.455	14.470	14.485	14.500
Harmonic distortion in db below the 1-kc/s output ..	31.5	34	34	35	36	37
Carrier Frequency (Mc/s) ..	14.515	14.530	14.545	14.560	14.575	—
Harmonic distortion in db below the 1-kc/s output ..	38	39	31	24	18	—

mately equivalent to -34 db, the discriminator with its visible kinks* is satisfactory over a carrier range of ± 50 kc/s, which was the design figure. This 2% includes all distortions in the system, and those *not* due to the discriminator probably amounted to about 1%. Only the wobulator and C.R.O. were used for alignment.

Detail of the Design and Alignment.—The major part of the circuit design was carried out according to the procedure outlined by Sturley.¹

The ratio E_2/E_1 of the secondary/primary voltages should be high: a value of 2 was adopted. If the working Q s of the primary and secondary are made equal, and if the coupling factor between the inductances is k , the product Qk should be as high as possible to give the maximum range of linearity, but should be low for maximum slope at the cross-over. Sturley suggests $Qk = 1.5$ as a suitable compromise and this was adopted. These data give the value 1.77 to the inductance ratio L_2/L_1 , where L_2 is the total secondary inductance.

The working Q s were determined by the peak to cross-over separation $\Delta f_0 = 175$ kc/s. For $Qk = 1.5$ and $f_0 = 14.5$ Mc/s, since $2\Delta f_0 Q/f_0 = 1.44$, $Q = 60$ and $k = 2.5\%$. These values are reasonable. The total secondary tuning capacitance was chosen to be 50 pF, giving $C_1 = 87.5$ pF, $C_2 = 50$ pF, $L_1 = 1.375$ μ H and $L_2 = 2.4$ μ H. The secondary inductance

primary and secondary are damped by the diodes. If the diode load resistances (R_2, R_3) in the circuit are each called R , the secondary is damped by an equivalent shunt resistance R (since the load resistances act in series). If the load centre-tap is taken straight to the primary, the primary will be damped by an equivalent resistance $R/4$. This damping is very severe. The value of R should therefore be as high as possible; 100 k Ω was chosen. A higher value would make it difficult to obtain the requisite flat audio response at 15 kc/s.

This would make the primary damping with direct connection to

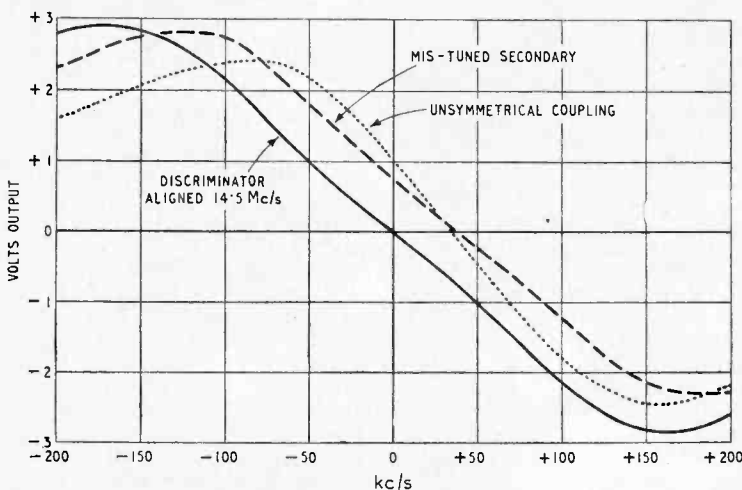

Fig. 2. The discriminator characteristic obtained after alignment using a wobulator and C.R. oscilloscope is shown by the solid-line curve and the effect of mistuning the secondary circuit is indicated by the dash line. Severe unbalance between the primary and the two half-secondaries, for which 'correction' for the unbalance was attempted by trimming adjustments, gives the dotted-line curve.

* Alignment was purposely curtailed to obtain these.

The inner frame-work, comprising the top, bottom and back, was made from Tufnol, the components being mounted directly on this. The important wiring (and, in particular, the lead from the primary through C_3 to the secondary and to the load) was screened to allow for slight adjustments with the screen removed. The brass stems of the slugs were also earthed. The variable parts of the primary and secondary tuning capacitors were air-spaced trimmers and each had a maximum of 20 pF. Compression type trimmers are unsuitable from the point of view of temperature coefficient, and a 10-pF trimmer would be less critical to adjust than a 20-pF. No particular care was taken with the fixed capacitors, although, if these had negative temperature coefficients, the overall stability would be improved. This does not, however, appear to be necessary. Quarter-watt resistors were used throughout and the values were found to be non-critical so that 10% tolerance components could be used. The filter capacitors C_4 and C_5 were T.C.C. silvered-ceramic components.

During preliminary testing some asymmetry of the characteristic was observed. This was found to be due to capacitive coupling between primary and secondaries. An electrostatic screen was fitted round the primary. It consisted of a number of U-sections of 24 S.W.G. silvered-copper wire joined externally at their centre points to earth. The long sides of the Us were fitted so that they were interposed between the primary and secondary windings, the common earth-strip being parallel to the primary winding. This screen can be seen in the photographs.

The primary coil was placed in position and the unit was wired. One half of the secondary was then fitted and the coupling was adjusted by means of a Q-meter to the required value. The other half of the secondary, wired in the correct sense, was secured in position at the same distance as the first from the primary. From the curves subsequently taken it would seem that small differences in the distance between the two half-secondaries and the primary do not seriously affect the characteristic. Provided the usual

checks are made on the uniformity of the dust-iron cores, and provided that the inductances are matched to 1% before fitting, it should be possible to set the coupling in each case by distance and to avoid the need for measuring the coupling factors.

Alignment Procedure. — After the I.F. amplifier and limiter had been adjusted for correct operation, the alignment of the discriminator was performed by

tic with the correct cross-over point. Only one factor remained to be fixed—the separation of the peaks which determines the linearity. As indicated by Sturley, this was adjusted by slight variations in the coupling, achieved by loosening the lock nuts and sliding the lead screws towards or away from the primary. A final check of the tuning was then made.

As has been mentioned, a

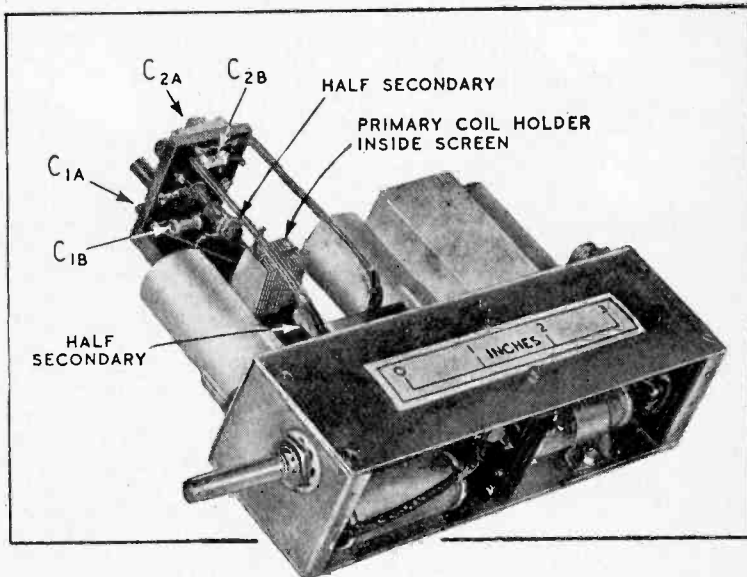

Another view of the discriminator. The U wires forming the electrostatic screen can be seen over the primary coil.

varying the factors mentioned earlier with the results already stated. The balance between the half-secondaries was adjusted before assembly as described previously. Subsequent deliberate maladjustment elicited the fact that the principal effect of this is to move the cross-over point. The complete procedure was as follows:—Using a C.R.O. and F.M. sweep generator, the deviation being 200-300 kc/s, the primary was adjusted by means of its trimmer to give equal peak amplitudes, positively and negatively. The secondary trimmer was then varied to give the correct cross-over point. To facilitate this adjustment the mid-frequency of the I.F. amplifier (14.5 Mc/s) was centred on the C.R.O., using a signal generator. Primary and secondary were then alternately readjusted to give the most symmetrical characteris-

C.R.O. is essential for the rapid adjustment of the three variables. If extreme linearity of the characteristic is sought, static measurements must be made, using the incremental scale of a signal generator. But if the C.R.O. does not show up the non-linearity, the distortion will be less than 2%, always assuming that the design procedure has been carried out intelligently.

Factory and Servicing Procedure.—After the adjustments detailed above have been made, the coupling should be locked and throughout the life of the discriminator unit it should not require further adjustment. The primary and secondary trimming capacitors should be accessible to the serviceman, although the writer believes that these too will require little attention. The stability of the coupling is due to the symmetry of the unit. Only dif-

Is Discriminator Alignment So Difficult?

ferential changes can upset the balance and these changes are negligible. Re-tuning the primary and secondary circuits does not require the use of a sweep generator or a C.R.O., much less a signal generator with an accurate incremental scale, for primary tuning is done by adjusting for

move in the same direction as the cross-over, and, although there is a slight difference in amplitude between the two peaks, the linearity is not affected. The distortion was again measured, and is shown in Table II.

Receiver mis-tuning over a range of 100 kc/s is still possible without distortion.

Effect of Unsymmetrical Coup-

TABLE II

Carrier Frequency (Mc/s) ..	14.440	14.455	14.470	14.485	14.500
Harmonic Distortion (db) ..	-23.5	-30.5	-35	-35	-35
Carrier Frequency (Mc/s) ..	14.515	14.530	14.545	14.560	14.575
Harmonic Distortion (db) ..	-36.5	-38	-40	-38.5	-33

equal positive and negative peaks when the receiver is tuned through resonance; and the secondary tuning is made by adjusting to zero output using a simple signal generator or even the B.B.C. signal itself.

Test Results.—The following quantitative results of tests give the performance of the unit.

Sensitivity.—The limiter operated satisfactorily with an R.M.S. signal of 2 volts. For 75-kc/s deviation this gave an audio output of 1.1 volts R.M.S.

Linearity.—The characteristic (Fig. 2) is linear up to ± 125 kc/s, if linear means that the distortion effect is less than 2%.

The distortion measurements were made with a G.R. audio oscillator, used to modulate a 14.5-Mc/s oscillator, the discriminator output being fed into a Hewlett-Packard analyser. The modulating frequency used was 1,000 c/s.

Carrier Detuning.—The net effect of detuning the carrier is exhibited in Table I, showing that ± 50 kc/s is tolerable.

Temperature Changes.—Using the construction detailed above and without temperature-compensated components, the cross-over point drift never exceeded 12 kc/s from "cold." This is only an indication of order of magnitude.

Effect of Incorrect Secondary Tuning.—The secondary was deliberately mis-tuned, until the cross-over point was 40 kc/s too high. The discriminator characteristic was then accurately measured. It is shown in Fig. 2. As was to be expected, the peaks

ling.—A very serious misalignment was simulated by reducing the coupling of one half-secondary to the lowest possible value, which was one-half of the original, maintaining the other at its correct value. This reduced the peak separation to about 240 kc/s, as compared with the previous value of 350 kc/s. The cross-over was raised in frequency some 30 kc/s and the peaks were unequal in amplitude.

The amplitudes of the peaks were then restored to equality by retuning the primary. The result is shown in Fig. 2, an example of very severe misalignment and wrong compensation. The linear range is severely contracted, and distortion will be great unless the carrier is near the cross-over. But even with this gross maladjustment, the figures for distortion given in Table III were obtained.

should never exceed 2 per cent. In general it should be much less. The same variations have no influence on signal/noise ratio, since the triangulation of the noise is independent of the cross-over point, so long as the carrier is on the linear part of the characteristic.

Conclusions.—A successful discriminator for F.M. is entirely feasible without any critical components. Inductances must be well balanced and an electrostatic screen between the primary and the secondaries is essential. Leads inside the discriminator box must be well screened. When coupling is adjusted to give the desired peak separation, close balance in coupling is *not* necessary.

Secondary tuning should be as accurate as possible, and should be done with a valve voltmeter across the discriminator output.

Factory alignment should be made using an F.M. sweep oscillator and C.R.O. Accurate final adjustment may be done using a signal generator and valve voltmeter, but this is not essential.

Servicing Alignment.—So long as the coupling factor between the primary and the secondary remains stable, the retuning of primary and secondary presents no difficulty, if it should be necessary. The unit should therefore be sealed so that coupling adjustment cannot be altered. For primary tuning a valve voltmeter is the only necessity, assuming that the receiver can be tuned, and that a B.B.C. signal is available. For secondary tuning even the voltmeter is unnecessary.

Finally it is emphasized that

TABLE III

Carrier Frequency (Mc/s) ..	14.470	14.485	14.500	14.515
Harmonic Distortion (db) ..	-11	-13.5	-18	-18
Carrier Frequency (Mc/s) ..	14.530	14.545	14.560	14.575
Harmonic Distortion (db) ..	-25	-32	-30	-24

Effect of Valve Change.—Six valves were tried and no variations beyond ± 6 kc/s change in cross-over were found. Valve change will therefore *never* necessitate retrimming.

Overall Effects.—With normal misalignments of discriminator tuning up to ± 20 kc/s and receiver oscillator tuning up to ± 30 kc/s, the total harmonic distortion with full 75-kc/s deviation

the purpose of this article is to examine the problem of discriminator alignment. With regard to the noise-reducing properties of the detector it has been amply demonstrated in recent years that the predicted F.M. performance can be achieved.

I am greatly indebted to my colleague P. E. Trier, M.A., for many helpful discussions regarding the design.

Harbour Radar

Details of the Equipment at Liverpool

A LARGE number of ships now carry navigational radar, and this new aid to navigation is doing much to reduce delays and hazards due to fog.

It has recently been realized that there is a need for shore-based radar to assist in the efficient running of a modern harbour in conditions of bad visibility. A ship approaching a harbour, particularly one which has a long approach channel, will be able to identify buoys and ships at the entrance to the channel up to a range of two or three miles, but, through lack of resolving power or because of obstacles, may not be able to see whether the channel is blocked at the far end by anchored vessels. The situation is beginning to arise where masters of incoming vessels contact the shore authority by radio and ask for a report of the state of the channel; this the shore authority is unable to provide in bad visibility without the help of radar. A similar situation arises in the case of a vessel wishing to sail and unable to observe the seaward end of the channel on her own radar, due either to dis-

By R. F. HANSFORD (Sperry Gyroscope Co.)

maintain a reliable check on the position of all the navigational buoys for which it is responsible.

In a large harbour the requirements which such a shore radar installation must meet are extremely stringent; often the width of the channel is only some thousand yards, and it will be required to observe with clarity ships at the end of this channel which may be 10 to 20 miles distant. This means that the radar must be capable of giving a very high degree of bearing discrimination, and that special large-scale displays will be needed. Factors such as ease of operation, accuracy, reliability and ease of maintenance are vital considerations which must be taken into account when the equipment is being planned.

In 1945 the Mersey Docks and Harbour Board discussed with the Admiralty Signal Establishment the possibilities of developing

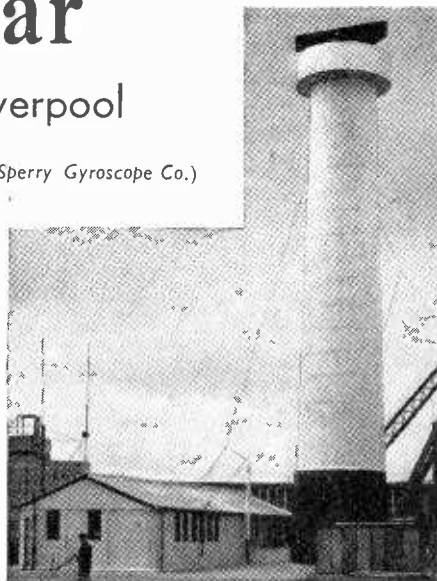

The aerial scanner unit is mounted at the top of an 80-ft. ferro-concrete tower.

of their high-discrimination radar equipment and arranged a temporary installation on top of a warehouse at the north-west corner of Gladstone Dock. Trials with this equipment were carried out, and although it was realized before the trials began that the performance of the equipment would not be up to the standard required by this particular task, very valuable information was given, and it was clearly seen that radar of the right characteristics could do the job. Eventually the Sperry Gyroscope Company were given a contract for the development and construction of the equipment required.

In the space available it is impossible to describe in detail the functioning of the whole equipment, but it may be of interest to describe briefly the broad outlines of the system, and this may best be understood by reference to the block schematic diagram, Fig. 1.

The Master Timer Unit contains a crystal oscillator which produces range calibrator pips at half nautical mile intervals, and, after frequency division, a firing pulse at 1,000 times per second for triggering the modulator. The modulator, in addition to pulsing the



Display console with centralized operating controls.

tance or screening. A further use for shore-based radar is that it allows the shore authority to

equipment to meet their needs. To assist in these discussions the Admiralty lent the latest version

Harbour Radar— transmitter after a 30- μ sec delay, provides a zero time pulse which is fed back through the Master Timer Unit, and gives a zero time clamp signal which is used to release the display sweep circuits at the correct instant. Also within the Master Timer Unit a circuit amplifies a bearing mark signal generated at the aerial at 5-degree intervals, which is then mixed with the range calibration signals and used to drive a 45-Mc/s oscillator so that the calibration signals can be fed into the I.F. chain. The transmitter-receiver is connected by waveguide to the

components of the aerial bearing. These are then fed into the X and Y integrators which convert them into saw-toothed time-base voltages which are then applied through amplifiers to the horizontal and vertical deflector coils of the display tubes. Whereas in normal P.P.I. practice the rotating time-base line is centred on the middle of the tube, in this case the centre is offset or in some cases is off the tube altogether, so that a distant section may be displayed on an enlarged scale. This is effected by passing the saw-toothed time-base voltages through voltage "gates" which

allows the mean position of the gate to be set at any desired point. Also included in each display unit are the last three stages of the I.F. amplifier chain and the detector and video amplifier for feeding the echoes and calibration marks to the grid of the cathode-ray tube.

The various power packs in the equipment all run from a 500-c/s supply, and their outputs are electronically stabilized. The stabilizers are all referred to a single reference voltage pack of high stability, so that any small changes which may occur in the

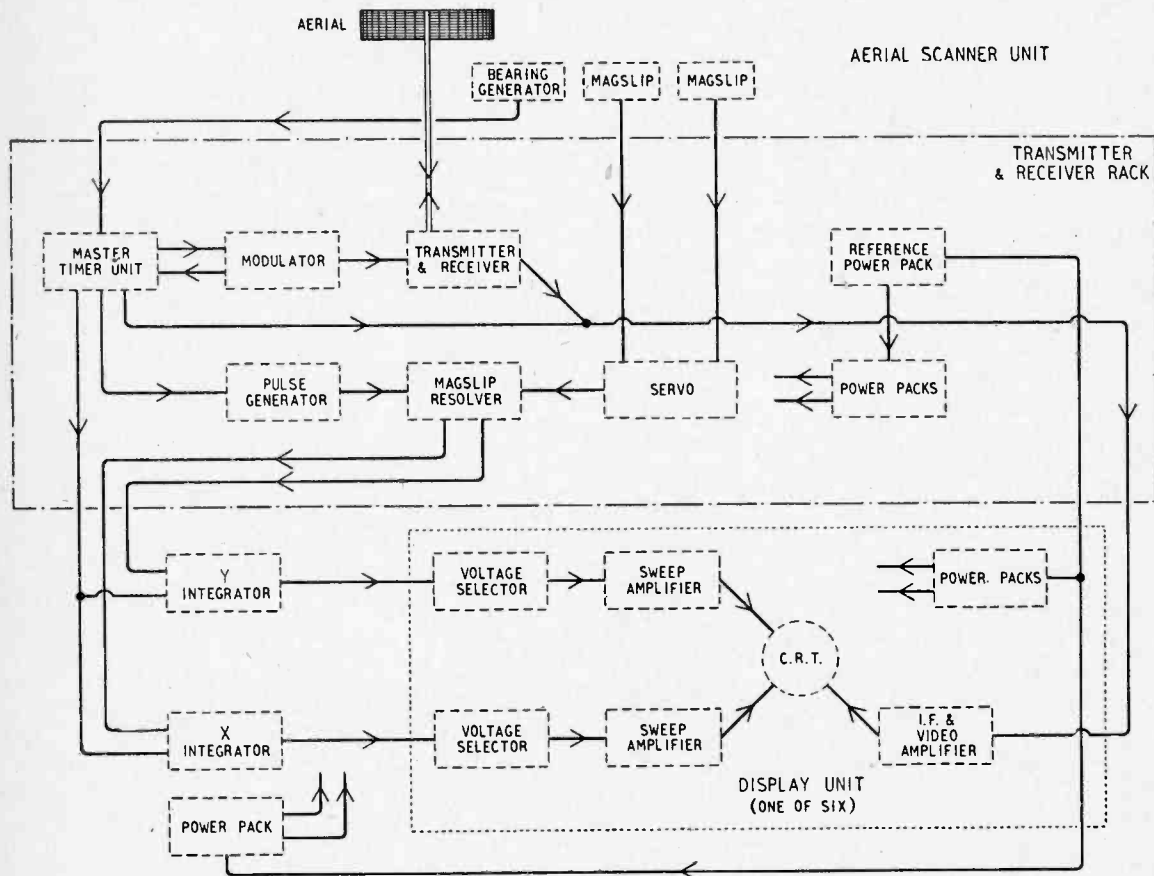

Fig. 1. Block schematic diagram of the shore-based radar installation at Liverpool, showing main divisions of the equipment.

rotating aerial scanner. The scanner has high-speed and low-speed mag-slip transmitters, which, through a servo amplifier, repeat the aerial position at a mag-slip resolver. The mag-slip resolver splits a square wave from a pulse generator into the E-W and N-S

select the interval of range to be displayed in each co-ordinate. Each "gate" is virtually a high-gain negative feedback amplifier capable of handling an input of only a few volts, and with the full sweep applied to its input. Adjustment of the bias setting

output of this power pack are precisely repeated by the remainder. Thus all voltages vary together and provide a degree of compensation.

To achieve a high bearing accuracy a large "cheese" aerial fifteen feet wide, two feet high

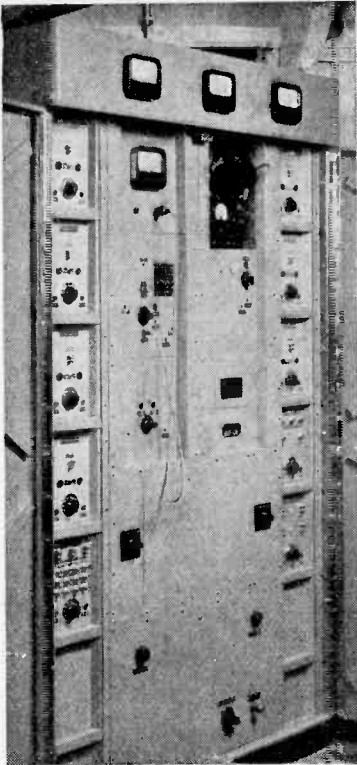

Main transmitter-receiver unit, with which is incorporated test equipment for monitoring the whole installation.

and weighing three-quarters of a ton has been constructed. (See front cover, *Wireless World*, July issue.) On test this aerial gave a beam width (total) of 0.7 degrees to 6 db points in the horizontal plane, and a vertical beam width (total) of 5 degrees. The aerial has been designed to very tight tolerances in order to keep down the side-lobe radiation. Test showed that a side-lobe value of 24 db down (48 db overall on echoes) has been achieved. One of the major tasks that was set in the design of this aerial was that its tolerances should be maintained despite wind velocities up to 100 miles per hour and despite changes of temperature. This aerial is rotated at 10 r.p.m. by a turning mechanism driven by a 6-h.p. electric motor and mounted in a completely closed room at the top of an 80-ft ferro-concrete tower, so that the mechanism is adequately protected, and can be worked on in comfort for the normal tasks of routine maintenance. The aerial

contains a number of heater elements of 25 kW total dissipation, thermostatically controlled for deciding in cold weather.

The transmitter consists of a 3-cm unit radiating a 0.25- μ sec pulse with a peak power of 30 kW; the same unit also contains the receiver circuits. This unit, together with the modulator, pulse generator, servo system, power packs, and control gear is mounted in a framework in the radar room adjacent to the base of the tower. This framework, in addition to the above main units, contains built-in items of test equipment for monitoring the whole installation.

The development and construction of the highly specialized display system for the installation was sub-contracted to A. C. Coscor, Ltd. The equipment comprises a large semi-circular console containing six plan-position indicators. The first display shows a small scale general view of the whole of Liverpool Bay, four more show large-scale off-centre true plan views of particular sectors of the approach channels, so that a large-scale mosaic is built up (Fig. 2).

The sixth display shows a large-scale plan which can be varied at will to cover any desired part of the Liverpool Bay. In all cases the large-scale displays are to the same scale to facilitate cross reference. They are all of true-plan

shape to aid recognition, and each has in front of it a reproduction of the chart, with a standard grid superimposed, so that echoes may easily be identified and their position rapidly fixed in terms of the standard grid, which is the normal method of measurement employed by radar operators. For test purposes the range and bearing markers may be switched on, and by pulling out the bezel containing the grid a number of range and bearing marks on a ring surrounding the C.R. tube can be observed. A check is then made for adjustment between the electronic and mechanical marks. When the bezel is replaced these marks are obscured and the electronic mark can be switched off, so that the operator is not confused by them. The display console also contains a set of controls by means of which the whole installation can be switched on and off and operated. To aid maintenance work, each of the six display units is mounted in a steel framework on wheels. In the event of one of these displays developing trouble it can be rapidly wheeled out and a complete display unit wheeled in to replace it. All sub-units of the display can be drawn out sideways on to a servicing tray for test or adjustment.

With the exception of the aerial and turning unit, all equipment, including a 50-kW diesel generator,

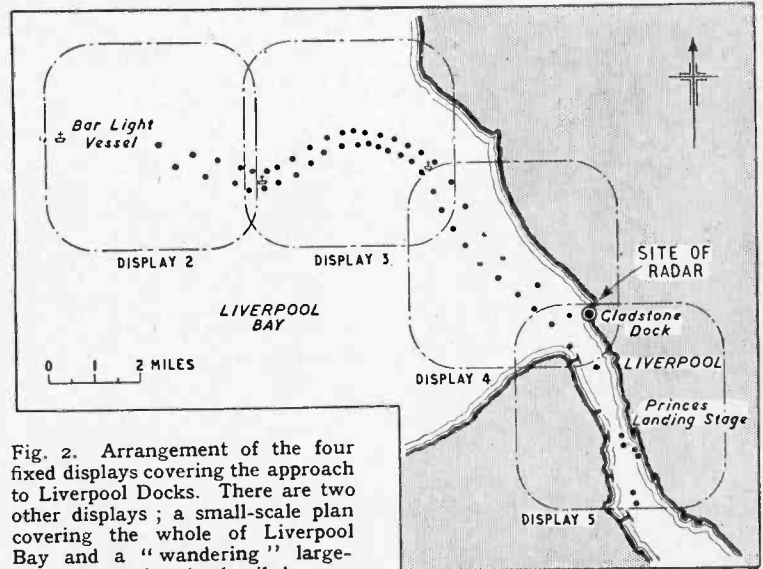

Fig. 2. Arrangement of the four fixed displays covering the approach to Liverpool Docks. There are two other displays; a small-scale plan covering the whole of Liverpool Bay and a "wandering" large-scale display for the detailed examination of any part of the Bay.

Harbour Radar—

is installed in a building at the base of the ferro-concrete tower. All cables and ventilating ducts for cooling the display and transmitter units are carried below floor level so that a neat appearance is maintained.

Further rooms in this building contain the Harbour Board's R/T and W/T communication equipment and a rest room for the operating crew.

The communication room contains two telephone lines connected to the Harbour Board Automatic Exchange, two direct lines to the Marine Dept. Office, a line to Post Office Telegrams, a teleprinter, and a land telegraph line to Point Lynas Signal Station, and the equipment for two radiotelephone links to ships at sea. One of these radiotelephone equipments works on 1,579 kc/s for communication with the Harbour Board's own vessels and lightships. The other radiotelephone operates on 8 Mc/s for communication with midget transmitter-receiver units carried aboard incom-

ing and outgoing vessels by the Liverpool Pilots. On this latter system, in order to receive the signals from the very low power transmitter in the portable equipment through the heavy interference at Gladstone Dock, a remote aerial 400 yards outside the dock has been installed with a two-valve wide-band booster at the aerial position.

A future development for Liverpool which has been seriously considered is the possibility of relaying the radar information by a radio link to a display console situated in the Harbour Board's offices.

Whilst the equipment has been designed specifically to meet the needs of Liverpool, there are many other large ports which present similar problems. Every port requires individual consideration and has individual requirements. The units designed for Liverpool have, however, been planned in a flexible manner, so that it should prove possible to use many of the existing units in future installations.

New Domestic Receivers

A TABLE model battery receiver (Model BC4956) with push-pull KT2s in the output stage is among sets recently introduced by the General Electric Company, Magnet House, Kingsway, London, W.C.2. The superheterodyne circuit operates on long, medium and short waves (16.5-50 metres) and requires a 2-volt L.T. and 135-volt H.T. supply. Piano-key controls are used for wave-range and on-off switching. The price is £29 7s 8d including tax, but excluding batteries. Another new G.E.C. set is the Model BT7094 radio-television receiver which is a console version of the Model BT7092 shown at Radiolympia last year. A flat-ended cathode ray tube is employed with a picture size of 8in x 6½in. The price is £118 11s 6d.

Murphy Radio, Welwyn Garden City, Herts, have produced a new "battle-type" receiver to be known as the "A124." Although it includes a short-wave range, the set has been designed primarily with an eye to high-quality reception from local stations, and particular attention has been given to the elimination of distortions associated with the A.V.C. circuits. The suppressor grid of the I.F. amplifier functions as an auxiliary diode for the delayed application of D.C. to the A.V.C. line. The price of the A124, which measures 20½in x 12½in x 8½in, is £20 3s 4d., including tax.

OUR COVER—New O.B. Television Gear

THIS month's cover illustration shows one of the three C.P.S. Emitron television cameras supplied, together with the associated O.B. equipment seen in these two photographs, to the B.B.C. by E.M.I. The camera, an experimental model of which was used at the Royal Wedding, has a rotatable triple-lens turret. Electronic view finding is provided and the picture is seen by the operator on a miniature C.R.T. In the semi-trailer transmitting van there are four

rack-mounted monitors, one for each of the three cameras and one for monitoring the outgoing picture. Above the racks is a receiver on which appears the picture received from Alexandra Palace—hence the dipole. The console receiver in the cover illustration is used to assist the commentator by displaying the scene being transmitted.

Part of the equipment installed in the van (right) is shown in the lower photograph.

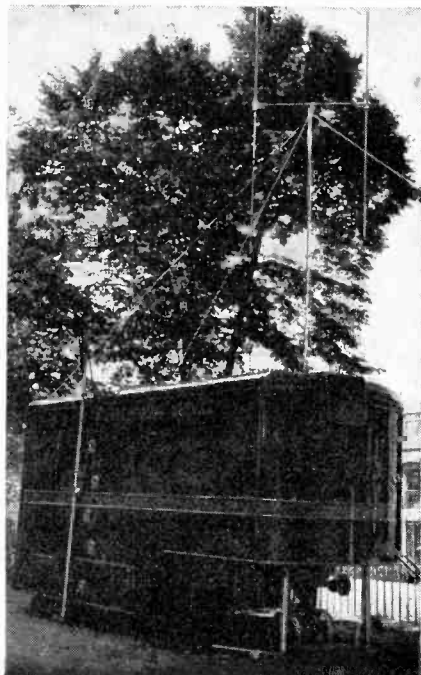
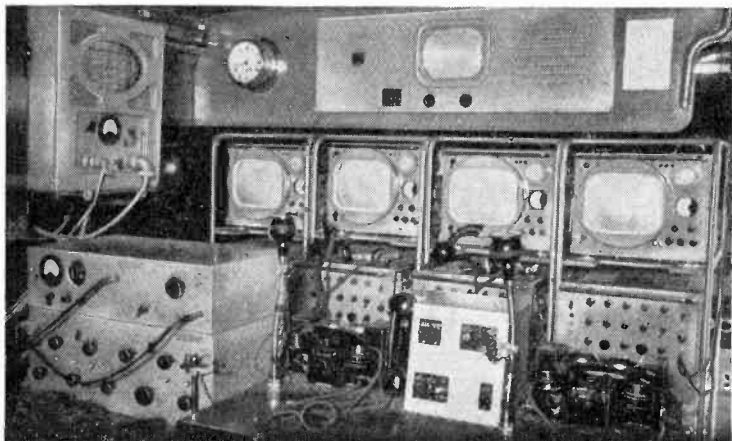

Electronic Circuitry

Selections from a Designer's Notebook

By J. McG. SOWERBY (Cinema Television Ltd.)

READERS are now quite familiar with the cathode follower, and it has come to be used for a wide variety of purposes. There are, however, various "snags" attached to its use, and these are not always realized.

Notes on the Cathode Follower

One of these results from the fact that the cathode follower as described in text-books, and the cathode follower as used in practice are not always quite the same thing, and in consequence the output resistance of the circuit is partially dependent on the input conditions—even at low frequencies.¹

The cathode follower as usually described is shown in Fig. 1, and the output resistance is usually taken to be $1/g_m$ (g_m being the mutual conductance of the valve), and this is usually a fair approximation to the truth which is

$$R_o = \frac{1}{g_m + 1/r_a + 1/R_c} \quad (1)$$

where r_a = anode resistance of the valve. Unfortunately the cathode follower as used in practice is seldom as simple as that shown in Fig. 1, and is more usually connected as shown in Fig. 2. Because the lower end of

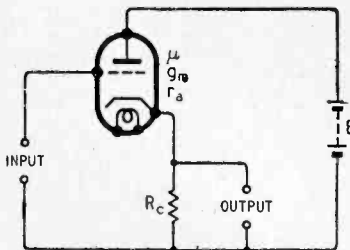

Fig. 1. Fundamental cathode follower circuit.

the grid leak is now taken to a tapping on the cathode load the output resistance will be found to vary with the input conditions. If the equivalent circuit of Fig. 2 is drawn and solved, one finds that

$$R_o = \frac{1}{g_m \left[1 - \frac{R_s}{R_s + R_g} \cdot \frac{R}{R + r} \right] + 1/r_a + \frac{1}{R + r}} \quad \dots (2)$$

and this obviously reduces to equation (1) when $R_s = 0$; in other words, when the input is short-circuited.

This dependence of the output resistance on the internal resistance of the source of the signal can, of course, be allowed for when the cathode follower is to be used under fixed conditions, and no difficulty arises. If, on the other hand, the cathode follower is the input stage of a general purpose

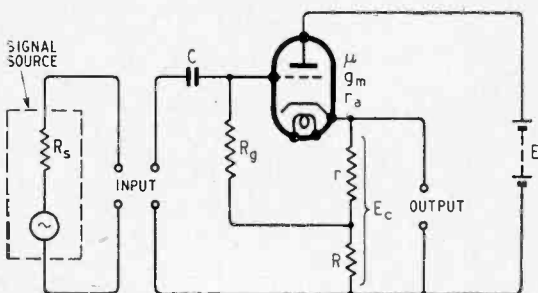

Fig. 2. Cathode follower with blocking condenser C in the input circuit.

amplifier—which may receive its signal from almost any source of supply—the variation of output resistance may have harmful effects.

The magnitude of the effect is best shown by means of a practical example. If we assume $g_m = 2.5$ mA/V, $r = 2k\Omega$, $R = 10k\Omega$, $r_a = 10k\Omega$, and $R_g = \frac{1}{2}M\Omega$, and calculate R_o for various values of R_s up to $10M\Omega$, we obtain the curve of Fig. 3. When the input is open-circuited R_o rises to 1,670 ohms—or more than four times the figure given by the usual approximation of $R_o = 1/g_m$.

If this were the only difficulty it would not be so bad. But when the cathode follower is the first stage in an amplifier one often relies for decoupling on the fact that any voltage change at its anode is considerably reduced at its cathode—by a factor which

R_o increases by a factor of more than four when the input is open-circuited, then it is only too clear that there will be an unfortunate drop in the decoupling factor of four times. Thus it is quite possible to have an amplifier (for an oscilloscope, for example) with a cathode follower input stage, which is quite stable when a megohm is placed across the input terminals, and yet which "motor-

boats" violently with the input open-circuited.

The foregoing difficulties can be overcome by the adoption of the circuit of Fig. 4, in which the cathode follower grid is biased positively by a potentiometer network across the H.T. supply. In the absence of grid current the output resistance will be constant whatever the internal resistance of the source of signal. Of course some of the H.T. fluctuations will be fed down the potentiometer

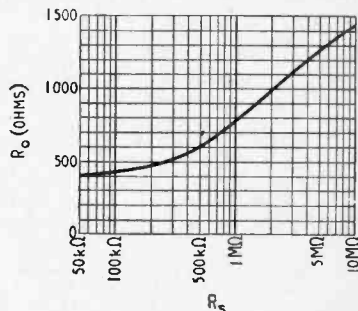

Fig. 3. Showing variation of R_o with R_s in a practical case.

network and will affect the decoupling; but this can be allowed for in the usual way.

The cathode follower is usually

we may call the decoupling factor, S , which is given by

$$S = r_a/R_o \quad \dots (3)$$

If, as in the foregoing example,

Electronic Circuitry—

thought of as a constant voltage device (low internal resistance), and as long as attention is confined to the grid and cathode terminals this is true. However, it presents a very large resistance, r'_a , at its anode:

$$r'_a = r_a + (\mu + 1)R_c \quad (4)$$

where μ = amplification factor of the valve and under proper conditions r'_a can compare favourably with the anode resistance of a pentode. Thus we may use the

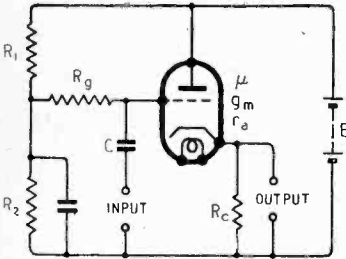

Fig. 4. Alternative cathode follower connection.

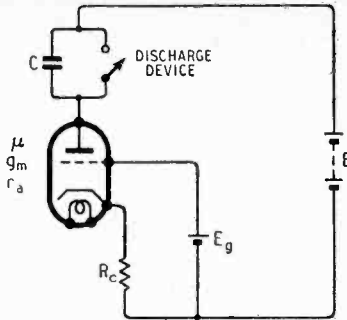

Fig. 5. Cathode follower as a charging device.

cathode follower for various purposes for which a pentode is normally used with resultant freedom from dependence on valve characteristics.

An obvious application is its use as a charging valve in a linear time base as indicated in Fig. 5. If $\mu = 80$, $r_a = 10k\Omega$, $E_g = 100$ volts, and $R_c = 100k\Omega$, so that the charging current is about 1 mA, C will appear to be charged from a source of about 8 kV

through a resistance of about $8M\Omega$. If the amplitude of sawtooth across C is 200 volts, it will be linear within a little over 1 per cent. The charging current can be controlled by variation of a part of R_c , and will be nearly independent of the valve characteristics.

Another application of the circuit is the stabilization of the current in a focus coil for a television C.R. tube. Here E_g is made 50–100 volts and is preferably stabilized with a neon tube. R_c is adjusted for the correct operating current, and the focus coil is placed in the anode lead. The valve should have the largest possible value of μ compatible with the ability to pass the required current for the focus coil. The current will then be largely independent of the resistance of the focus coil—which may well vary with temperature—and will depend chiefly on the voltage across the neon tube, and on R_c .

¹ Lockhart, C. E., *Electronic Engineering*, Dec., 1942.

Standard Frequency Transmissions

Present Position in this Country

IT will be recalled that at last year's meeting of the International Telecommunications Union at Atlantic City, it was agreed that the frequencies 2.5, 5, 10, 15, 20, and 25 Mc/s should be allocated on a world-wide basis for all future standard frequency transmissions. If, therefore, interference between such transmissions in various parts of the world is to be avoided, all new services of standard frequency broadcasts will require very careful co-ordination. At present standard frequency transmissions of guaranteed accuracy are continuously emitted by the U.S.A. National Bureau of Standards station, WWV, on all the above frequencies, and in addition on 30 and 35 Mc/s. A summary of these transmissions was given last month on p. 293.

In a recent communication from the Department of Scientific and Industrial Research it is pointed out that unfortunately, on account of radio propagation conditions, it is often difficult to make use of the U.S.A. transmissions in Europe and farther east. The question of radiating standard frequency transmissions from this country has there-

fore been under consideration.

Experimental low-power transmissions on a frequency of 2 Mc/s have been made for some time by the Royal Observatory from station GMT at Abinger, Surrey, to facilitate comparisons between quartz clocks used in the operation of the Greenwich time service. The daily schedule begins at 09.58 (G.M.T.) with a voice announcement of the call sign. From 10.00 to 10.15 the carrier is radiated unmodulated and from 10.15 to 10.25 a 1,000-c/s modulation is applied. The transmission closes with a voice announcement when the provisional correction to the transmitted frequency is announced in parts in 10^6 . The corrections are normally accurate to about ± 2 parts. Since no other British standard frequency service is at present available these transmissions have been fairly widely used, and a substantial increase in power, which is at present 350 watts, is under consideration.

In existing circumstances the provision in this country of a comprehensive service on a number of the available frequencies will take some considerable time; but arrangements are now under consideration

whereby a limited standard frequency service on three frequencies will be operated by the General Post Office. It is hoped that these experimental transmissions will demonstrate the feasibility and value of United Kingdom and European coverage, and also the degree of interference from and with WWV.

Details of this experimental service will be announced later, but meanwhile those who require such a service may be interested to know that the frequencies of the following transmitters of the G.P.O. and of the B.B.C. are maintained at their nominal values to a tolerance better than \pm one part in 10^6 .

Call Sign	Station	Nom. freq. (kc/s)
GBR	Rugby	16
	Droitwich	200
GRO	Skelton	6,180
GSB	Daventry	9,510
GSV	Daventry	17,810

It may further be noted that all B.B.C. medium-wave transmitters, with the exception of that on 583 kc/s (514 m), are also maintained on their nominal frequencies to a tolerance of approximately \pm one part in 10^6 .

Electronics at Harwell

An Indispensable Tool in Atomic Research

THE technique of research into the problems of nuclear physics is dependent to a considerable extent on the application of electronic methods, not only for the generation of high particle energies and

bare facts with some details gleaned at first-hand during a recent visit to the Atomic Energy Research Establishment at Harwell.

Construction of the 700-ton electromagnet for the Harwell cyclotron is nearing completion and it is expected that the machine will be running at the end of this year. The pole diameter is 110 inches and the final gap 12 inches. Oil cooling is provided for the field windings, which carry 600 A at 500 V. A self-oscillating R.F. generator rated at 150 kW supplies the potential difference to the D-shaped box electrodes in which the particles are accelerated *in vacuo* in a spiral path. To secure effective bunching and to main-

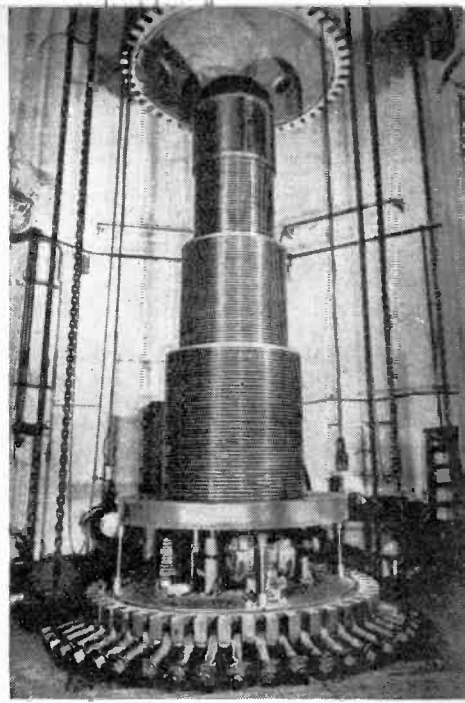

[All photos Crown Copyright reserved.]

tain acceleration against the relativistic increase of mass, as the particle velocity approaches the speed of light, the frequency is modulated between 19 and 27 Mc/s. The repetition rate is 200 per second. With this machine heavy particles such as protons or deuterons will be given energies of the order of 200 Mev and will enable nuclear transformations to be made which are beyond the capabilities even of the atomic piles.

A Van de Graaff electrostatic gen-

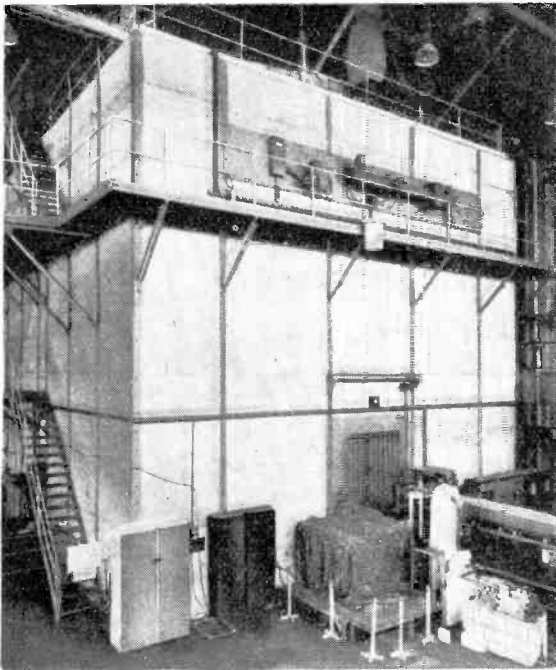

General view of "Gleep," the 100-kW atomic pile, and (right) control room with instruments for recording neutron density, temperature, etc.

the routine control of nuclear reactions in atomic piles, but also in the detection of harmful radiations and the safeguarding of the health of workers. Readers of this journal¹ are already familiar with the broad principles involved, and we are now able to supplement the

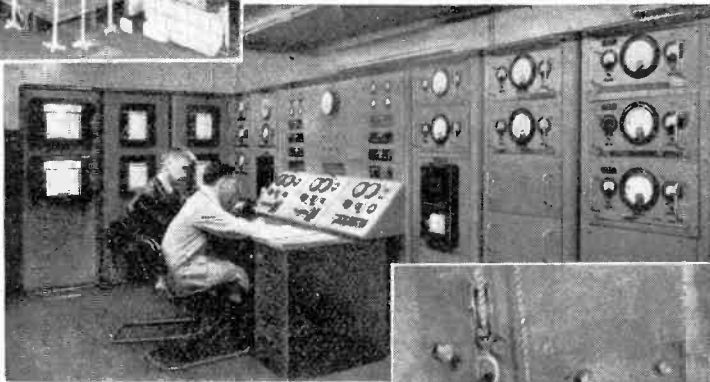

Withdrawing aluminium capsules containing artificially-produced radioactive chemicals from the atomic pile. An electronic health monitor is seen in the left-hand corner of the

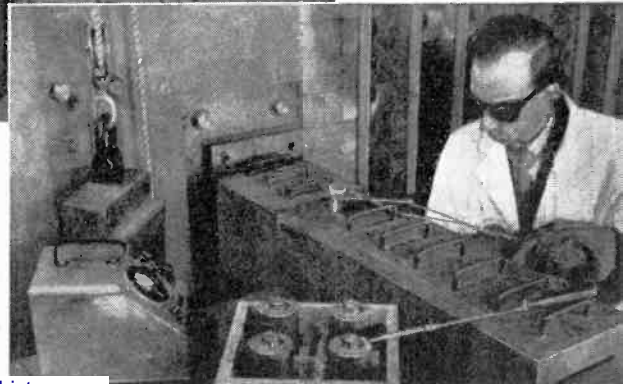

¹ "Electronics and Atomic Energy," by E. W. Titterton, *Wireless World*, Feb., 1948.

Electronics at Harwell—

erator for 5 MV is under test and will be used with a linear accelerator tube for the precise measurement of nuclear reaction energy levels. Although less powerful than the cyclotron, the advantage of the electrostatic generator is that the voltage can be held steady by electronic servo control to any required value with an accuracy better than 1 per cent.

Other accelerators under development at the Telecommunications Research Establishment at Malvern include a synchrotron in which particles are accelerated in a fixed circular orbit under the influence of a varying magnetic field and an auxiliary R.F. electric field, and a waveguide linear accelerator in which electrons are carried, as it were, on the crest of a travelling wave.

The two atomic piles—"Gleep" (graphite low-energy experimental pile) of 100 kW and "Bepo" (British experimental pile) of 6,000 kW—rely extensively on electronic monitoring of temperature and neutron density for their safe operation. An elaborate system of relays is arranged to shut down the pile in the event of excessive temperature rise or external radioactivity. The cadmium rods which absorb neutrons and damp down the nuclear reactions are suspended from magnetic clutches, which automatically release and allow the rods to fall into the pile in the event of failure of the power supply. Ionization chambers, containing boron trifluoride gas, are embedded in the pile, and, as an indirect result of nuclear reaction between the electrically inert neutron particles and the boron atoms, produce ionization pulses which can be counted electronically to indicate the neutron density.

For the detection and measurement of harmful radiations there are a variety of relatively simple electronic instruments. The most commonly used "health monitor" consists of an ionization chamber connected to an amplifier and a microammeter. It is battery operated and housed in an aluminium box approximately 9 in cube; an alternative design is in the form of a pistol. This type of instrument gives an indication

of the instantaneous radiation

Where a knowledge of the integrated dose over a period is required, workers carry a small condenser capsule having a capacitance of a few pF and very high insulation resistance. This is charged to a fixed value (say 100 V) and after exposure to radiation, the drop in voltage due to ionization is measured in a valve electrometer circuit. Thus workers can satisfy themselves of the safety of local working conditions without having to wait for the processing and measurement of the X-ray test film which all employees must carry, and which is collected periodically for development and routine examination for evidence of excessive exposure to radiation.

Also under development for carrying in the pocket is a miniature quartz-fibre electrometer working on the principle of the

gold-leaf electroscope—one of the earliest methods of detecting radioactivity. The instrument is rather like a pocket telescope, and by holding it to the light the precise setting of the fine quartz fibre can be read off against a graticule scale.

Electronic techniques have been developed for controlling the operations of radio-chemical analysis, for checking that chemists have washed their hands properly before leaving the building and for testing the effluent from the Establishment before it is returned to the Thames. In fact, the outstanding impression of the visit to Harwell is that electronics is accepted there not merely as a name to conjure with, but as a most effective tool which is made to work hard and has already paid handsome dividends in the technological progress so far achieved.

News from the Clubs

Derby.—A series of lectures and demonstrations on television home construction is being given at the fortnightly meetings of the Derby and District Amateur Radio Society held on alternate Wednesdays at 67B, London Road, Derby. Sec.: F. C. Ward, G2CVV, 5, Uplands Avenue, Littleover, Derby.

Grimsby.—For the benefit of beginners a series of lectures on basic theory is to be given at the weekly meetings of the Grimsby Amateur Radio Society. Meetings are held on Thursdays at 7.30 at 115, Garden Street, Grimsby. Sec.: R. F. Borrill, G3TZ, address as above.

Oldham.—Meetings of the Oldham Radio Society, which has been reformed, are held on the second and fourth Wednesdays of the month at 7.30 at the Civic Centre, Clegg Street, Oldham. Particulars are available from E. Hulme, G3BQT, 20, Parkway, Chadderton, Nr. Oldham, Lancs.

Peterborough.—An exhibition is being held by the Peterborough and District Radio and Scientific Society in the Town Hall, Peterborough, on September 18th from 10 a.m. to 10 p.m. In addition to the society's exhibits the G.P.O. and some local dealers are exhibiting. Meetings of the society are held at 61, Padholme Road, on Tuesdays and Thursdays at 7.30 and on Sundays at 10.45 a.m. The Tuesday meetings are devoted to instruction for those taking the City and Guilds amateurs' exam. Sec. S. Woodward, 72, Priory Road, Peterborough, Northants.

Romford.—At the September 14th meeting of the Romford and District Amateur Radio Society a demonstration lecture on television will be given. Meetings are held each Tuesday at 8.0

at the Y.M.C.A., Western Road, Romford. Sec.: R. C. E. Beardow, G3FT, 3, Geneva Gardens, Whalebone Lane North, Chadwell Heath, Essex.

Solihull.—Meetings of the Solihull Amateur Radio Society are held on alternate Wednesdays at the club H.Q., The Old Manor House, Solihull, where visitors are welcome. Sec.: H. C. Holloway, 20, Danford Lane, Solihull, Warwick.

Southall.—Among the facilities provided by the West Middlesex Amateur Radio Club is a library of technical books donated by members. The club has taken out subscriptions for some hard-to-come-by journals, which are circulated among members at a nominal fee. Meetings are held on the second and fourth Wednesdays of each month at 7.30 at the Labour Hall, Uxbridge Road, Southall. Sec.: C. Alabaster, 34, Lothian Avenue, Hayes, Middx.

Thames Valley.—An 80-metre field day is being held by the Thames Valley Amateur Radio Transmitters' Society on August 29th from 11.0 a.m. to 7.0 p.m. for a challenge cup. Meetings are held on the first Wednesday of each month at 8.0 at the Carnarvon Castle Hotel, Hampton Court. Sec.: A. Mears, G8SM, Broadfields, East Molesey, Surrey.

West Cornwall.—Meetings of the West Cornwall Radio Club are held each month in three centres, Penzance, Falmouth and Redruth. Details of the winter's programmes, which are arranged independently by each centre, are available from R. V. A. Allbright, G2JL, "Greenacre," Lidden, Penzance; L. Rogers, G2FQD, 25A, Arwenack Street, Falmouth; or E. W. Johns, 44, Albany Road, Redruth. The Penzance centre plans to run a special course for those taking the radio amateurs' exam.

Manufacturers' Products

Auto-switch Permeability Tuner

THE Weymouth tuner illustrated is the type B₃S, intended for use in the construction of a domestic broadcast superhet receiver. It has the advantage of being very compact as the whole unit, which covers 200 to 540 and 1,000 to 2,000 metres, measures only $4\frac{1}{2} \times 2\frac{1}{4} \times 3\frac{1}{2}$ in.

Tuning is effected by means of dust-iron cores sliding in and out of long small-diameter coils and each circuit—there are four in all—is shunted by a small fixed capacitance and a variable trimmer.

A feature of no little interest is that at appropriate positions of the tuning spindle cam-operated switches automatically change from one waveband to the other, so a 360-degree rotation of the spindle gives continuous tuning over the whole of the medium and long waves, or in the case of the export model, of the

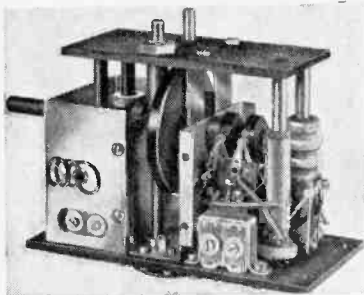

Weymouth two-range permeability tuner with automatic waveband switching. One half of the screening cover is removed.

medium and short (18 to 45 metres).

Accompanying each unit is a circuit giving the appropriate values of the few additional parts needed for the frequency changer with an I.F. of 470 kc/s.

The makers are Weymouth Radio Manufacturing Co., Ltd., Crescent Works, Weymouth, Dorset, and the price is 45s.

Ceramic Capacitors

TWO new models have recently been added to the range of capacitors embodying "Hi-K" ceramic material made by the United Insulator Co., Ltd., Oakcroft Road, Tolworth, Surrey.

One is a 1,000-pF model for operation up to 10 kV, intended for use in television and C.R. equipment as a smoothing, or H.T., by-pass capacitor. It measures approximately 2 in.

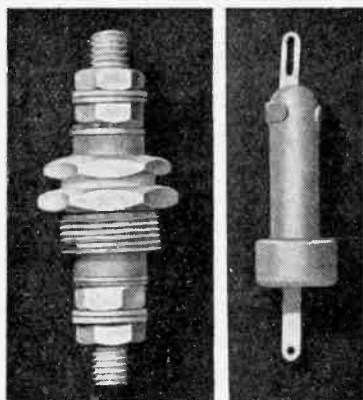

United Insulators feed-through model for transmitters (left) and television H.T. ceramic capacitor.

long and $\frac{3}{4}$ in diameter at the base.

The other new item is a heavy-current lead-through capacitor for use in radio heating apparatus and high-power transmitters. It, also, has a capacitance of 1,000 pF and is rated to carry 200 amperes of radio frequency. This model is fitted with heavy-duty panel bushes and a large diameter centre spindle.

Varley Output Transformer

A HEAVY-DUTY universal output transformer (Model DP61) capable of handling 20 watts of audio with minimum distortion has been introduced by Oliver Pell Control, Ltd., Cambridge Road, Woolwich, London, S.E.18.

It can be used with either push-pull or single valve output stages and provides the choice of eleven ratios of from 13 to 1 to 100 to 1.

The primary resistance is about 300 ohms each side of the centre tap and the overall inductance is 45 henrys. Sectionalized and inter-

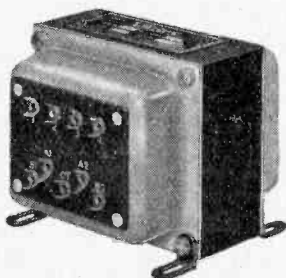

Varley Model DP61 multi-ratio transformer.

leaved windings are used to ensure a level response over a wide frequency range. The primary will carry 200 mA when the transformer is used in a push-pull circuit. The price is 45s.

Communal Hearing Aid

A VERSATILE sound reinforcement system installed recently by N. Miers and Company, of Epping, Essex, in the Leo Bonn Memorial Hall of the National Institute for the Deaf provides for the use of three microphone inputs, for gramophone reproduction, for amplifying the sound track of cinema films and for radio reception.

Amplification and frequency compensation are effected by a Model R1 recording amplifier made by Birmingham Sound Reproducers and the output is distributed between a few specially designed loudspeakers and from 40 to 50 headphones and

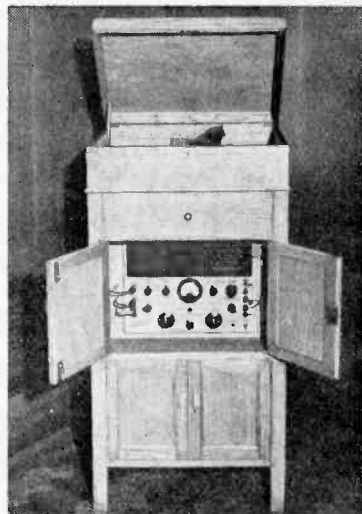

All-purpose hearing aid equipment comprising amplifier, gramophone unit and storage space for records installed in the National Institute for the Deaf.

bone-conduction receivers. Each of the last-mentioned includes a small control unit incorporated in the lead for individual adjustment of volume.

The amplifier has a push-pull output stage with negative feedback and is capable of giving up to 20 watts output with negligible distortion.

Four input circuits feeding into two separate pre-amplifiers with independent volume controls are provided and common to all input channels is a very wide range tone control with separate adjustments for bass and treble.

Negative Feedback

THE use of negative feedback in A.F. amplifiers is now firmly established and many good designs have been published in *Wireless World* and elsewhere. The application of feedback to an existing amplifier involves a certain amount of calculation, however, and the methods to be adopted do not seem to be as well-known as they should be. While exact formulae, which take everything into account, are apt to be rather cumbersome for the layman to handle, it is possible to use very simple, approximate expressions which are sufficiently accurate for most ordinary purposes. These, together with a few elementary rules which should be observed when using feedback, enable the person with little mathematical skill or knowledge to design a feedback circuit suitable to his amplifier and his requirements.

It is proposed to show in detail the use of these formulae, giving numerical examples in each case. The actual calculations can often be simplified by using the data lists or abacs which can be found in reference books such as Langford Smith's "Radio Designer's Handbook." Even the small abacs printed in the *Wireless World* Diary can aid evaluation considerably and are of sufficient accuracy.

Stage Gain

The first formula we require is the well-known one for the gain of a single RC-coupled valve, Fig. 1, and is,

$$A = \frac{\mu}{1 + r_A/R_L} \quad \dots \quad (1)$$

Where A = gain from grid of V_1 to grid of V_2 .

μ = amplification factor of valve.

r_A = anode A.C. resistance of valve.

R_L = anode resistor.

It should be realized that this is not strictly accurate since it does not take into account the following grid resistor, R_G , which, as far as the valve is concerned, is in

parallel with the anode resistor. As the grid resistor generally has a value of five or more times the value of R_L , the error is not great, and the formula is greatly simplified by the omission of the shunting effect. There is little need for extreme accuracy in

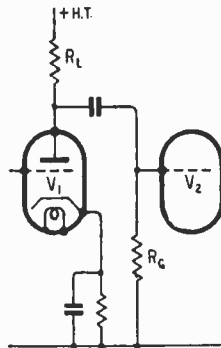

Fig. 1. Basic circuit of an RC-coupled stage.

working out our results. Indeed it is foolish to attempt it, since the figures given by the valve manufacturer are average values for a large number of samples and there may be appreciable differences in individual cases. The valve constants are by no means constant over the range of possible working voltages but only approximately so. The gain obtained in practice leads one to assume that the values given are the optimum ones, since the calculated gain is rarely achieved. Similarly the resistor values may vary by ± 20 per cent, and sometimes even more.

The formula therefore, gives a value for the gain which is approximate only, the approximation being generally too large.

Example 1. Find the gain of a single stage using one 6J5 valve and a 50-k Ω anode resistor. From the manufacturer's published data we find that $\mu = 20$, $r_A = 7,700\Omega$.

Using formula (1),

$$A = \frac{20}{1 + 7,700/50,000} = \frac{20}{1.15} \approx 17$$

In the R.C.A. valve manual the gain for a 6J5 with a 50-k Ω

anode resistor is given as 14, the anode supply being 300 volts and the following stage grid resistor 100 k Ω . This is 82 per cent of the calculated gain and serves as a useful guide to the degree of error.

If we have two such stages of amplification the resultant total gain will be $14 \times 14 = 196$.

Some manufacturers give the valve constants in terms of the mutual conductance, g_m , in mA/V and either the amplification factor, μ , or the anode A.C. resistance r_A . The three quantities are related by the equation,

$$\mu = \frac{g_m r_A}{1,000} \quad \dots \quad (2)$$

so that any one can be found if the other two are known. Thus, for a Tungram HL4+, the manufacturers give $r_A = 10,000\Omega$ and $g_m = 3.5$ mA/V, so that the amplification factor,

$$\mu = \frac{3.5 \times 10,000}{1,000} = 35.$$

Current Feedback

There are two types of feedback, current feedback and voltage feedback. In the first the amount of feedback depends on the current in the output load. Current feedback is generally applied to one stage only and common examples are (a) the omission of the bias resistor by-pass capacitor, (b) the cathode-follower type phase-splitter which has equal loads in anode and cathode circuits, and (c) the cathode-follower detector, also known as the infinite impedance detector. Current feedback causes a rise in the output resistance of the valve and should therefore not be used in an output stage, where, as explained later, a lowering of the resistance is much to be preferred.

In voltage feedback the amount of feedback depends on the voltage across the output load. It is the type most commonly used when feedback is taken from the output stage and applied over one or more stages of an amplifier.

Probably the simplest way of applying feedback is by omitting

Calculations

Simplified Design Formulae

By E. J. JAMES, B.Sc.

the bias resistor by-pass capacitor, as shown in Fig. 2, so giving current feedback. The gain, from input at grid to output at anode is, in this case, given by

$$A' = \frac{\mu R_L}{(\mu + 1) R_K + r_a + R_L} \quad (3)$$

where R_K = cathode resistor.

Example 2. Find the gain of a 6J5 with a 50-k Ω anode resistor and an unbypassed cathode resistor of 2k Ω .

Using the valve constants as given in Example 1, the gain,

$$A' = \frac{20 \times 50,000}{21 \times 2,000 + 7,700 + 50,000} = \frac{10,000}{997} \approx 10$$

Comparing this with Example 1 we see that the calculated gain is reduced from 17 to 10, and harmonic distortion generated in the valve will be reduced in the same ratio.

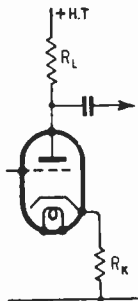

Fig. 2. Illustrating feedback from a cathode resistor.

In a phase-splitter there are, of course, two outputs. Equation (3) gives the gain from grid input to anode output. The cathode output will be equal to that of the anode but in opposite phase.

Example 3. Find the gain of a phase-splitting stage, Fig. 3, using an MHL4 with anode and cathode resistors of 25k Ω , the bias resistor being 1k Ω , unbypassed.

The total resistance in the cathode circuit is 26k Ω . The gain is given by,

$$A' = \frac{20 \times 25,000}{21 \times 26,000 + 8,000 + 25,000} = \frac{500}{579} \approx 0.9$$

The values for the valve constants, μ and r_a , are taken from the

manufacturer's literature as before.

The voltage fed to each side of the first push-pull stage will therefore be 0.9 times the input voltage to the phase-splitter and so the total gain of the stage is 1.8. The gain of this type of phase-splitter is fairly constant regardless of the values of resistors and of the valve employed, and rarely differs much from 1.8—1.9. Incidentally, an easy way of obtaining balance in the amplifier is by substituting a variable resistor for the 25-k Ω resistor in the cathode circuit. A 50-k Ω potentiometer, which should be of adequate wattage, provides a more than sufficient range of control.

Amplifier Gain

We are now in a position to calculate the overall gain of an amplifier. Generally we only need to find the gain as far as the input grids of the last stage so that the amplifier input necessary for maximum power output can be stated. But feedback is often taken from the anodes of the output valves or from the speaker-transformer secondary, so that we must be able to find the gain at both these points as well. The gain of the output stage depends, as in other stages, on the load in the anode circuit. The load in this case is the speaker impedance reflected into the transformer primary and so depends on the transformer ratio. The relationship between these quantities is expressed by the equation,

$$n = \sqrt{Z_L/Z_S} \quad \dots \quad (4)$$

$$Z_L = n^2 Z_S \quad \dots \quad (4a)$$

where n = transformer ratio
 Z_L = load impedance in anode circuit
 Z_S = speaker impedance

Example 4. Find the gain of the amplifier shown in Fig. 4 calculated from input to (a) output anodes, (b) output transformer secondary. Also find the

input required for full output. All essential values are shown in the diagram, and only those parts which are necessary for the calculation are shown.

1st Stage. The valve constants for the MH4 are $\mu = 40$, $r_A = 11,100\Omega$. Using formula (1), the gain =

$$\frac{40}{1 + 11,100/50,000} \approx 32$$

2nd Stage. We may assume the gain of the phase-splitter to be 1.8; the variation is so small that there is little point in evaluating it.

3rd Stage. For a PX25, $\mu = 9.5$, $r_A = 1,265\Omega$; with 400 volts on the anodes the grid swing required for the maximum output of 15.5 watts is 76 volts, grid-to-grid.

The load reflected by the speaker to the transformer primary is $Z_L = 18^2 \times 15 = 4,860\Omega$. This is the load for both valves, so for one it is 2,430 Ω .

$$\therefore \text{Gain} = \frac{9.5}{1 + 1,265/2,430} \approx 6$$

\therefore Gain (input to anodes of output valves) = $32 \times 1.8 \times 6 \approx 346$. If we include the output transformer, the gain from the input to transformer secondary becomes $346/18 \approx 19$.

The gain up to the grids of the output valves is 32×1.8 , so that the input voltage required at the grid of the MH4 to give us the required 76 volts at the PX25 grids is,

$$\frac{76}{32 \times 1.8} \approx 1.3V$$

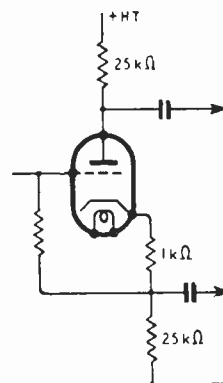

Fig. 3. Typical phase-splitter.

The gain in the output stage may be calculated in another way which is often to be preferred

Negative Feedback Calculations— since the required data is more readily available. The peak voltage across the secondary of the output transformer is given by

$$V_s = 1.414 \sqrt{WZ_s} \quad \dots (5)$$

where W = output power in watts
 Z_s = speaker impedance.

while the primary voltage is,

$$V_p = nV_s = 1.414 \sqrt{WZ_L} \quad (5a)$$

Using the figures given for the output stage above,

$$V_s = 1.414 \sqrt{15.5 \times 15} \approx 22V.$$

This voltage across the speaker transformer secondary is developed by an input to the grids of the PX25 valves of 76V, so that the gain of the last stage, including

the speaker transformer is $\frac{22}{76} =$

0.29. Notice that here again there is a discrepancy between the results obtained by the two methods, this time of approximately 12 per cent.

The value of the transformer ratio is determined by the load required by the output valves and the speaker impedance. The optimum load for an output valve is given in the manufacturer's data and the transformer ratio is then chosen so that the speaker

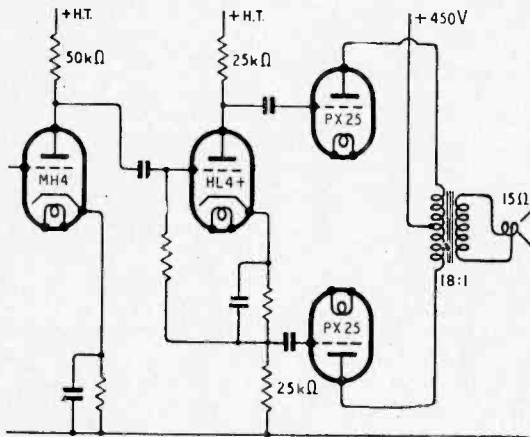

Fig. 4. Amplifier circuit used to illustrate the calculation of gain.

presents this load to the valve. Equation (4) is the one to use for this calculation.

Feedback Factor

When voltage feedback is applied to an amplifier both gain and distortion are divided by an amount

$$F = 1 + A\beta \quad \dots (6)$$

where A = normal gain without feedback. β = fraction of output voltage fed back. (Negative feedback is assumed wherever feedback is mentioned in this article.) This reduction refers, of course, only to that part of an amplifier in which feedback is used. The reduction factor,

$1 + A\beta$, is conveniently known as the feedback factor.

The calculation of β is generally a simple matter since the voltage is fed back through resistors which form a potentiometer. Two typical examples of feedback lines are shown in Fig. 5 and it will be seen that the output voltage is across $R + r$, while the feedback voltage is applied across r . The blocking capacitor C in Fig. 5 (a) will be dealt with later. It is obvious that

$$\beta = \frac{r}{R + r} \quad \dots (7)$$

Example 5. An amplifier has a normal gain, without feedback of 40. Feedback is applied through resistors of $1k\Omega$ (r) and $9k\Omega$ (R). Find the gain with feedback.

Using equation (7)

$$\beta = \frac{1,000}{9,000 + 1,000} = \frac{1}{10} \quad (\text{This is sometimes referred to as } 10 \text{ per}$$

cent feedback.)

The feedback factor is then obtained by means of equation (6) and is $1 + 40/10 = 5$.

$$\therefore \text{Gain (with feedback)} = 40/5 = 8.$$

Distortion will also be reduced by the same amount, so that if 5 per cent was present originally, the distortion with feedback would be 1 per cent.

To avoid undue waste of power the feedback resistances should not be too small; if possible, not less than 10 to 20 times the output-circuit impedance. Thus, if feedback is taken from a speaker-transformer secondary of impedance 15Ω , the feedback resistances

should have a minimum value of 150–200 Ω .

The blocking capacitor C of Fig. 5(a) should be chosen so that its reactance in ohms at the lowest frequency required is small, about 1/10 or less, compared to its associated resistance R . The reactance may be found in the data lists or can be calculated from

$$X_c = \frac{159,000}{fC} \quad \dots (8)$$

where X_c = reactance of capacitor in ohms.

f = frequency in c/s.

C = capacitance in μF .

Taking 30 c/s as the lowest frequency required, equation (8) may be rearranged in the form

$$C = 53,000/R \quad \dots (8a)$$

to give us an approximate value required for C in μF when R is known. For example, the capacitance to be used with a 20-k Ω resistor should be 53/20 μF , or about 2.5 μF . An electrolytic capacitor may be used as a polarizing voltage is provided by the anode supply.

When feedback is taken to a cathode-bias resistor its by-pass capacitor is, of course, omitted. This introduces current feedback in the first stage of the feedback loop and gain must be calculated accordingly.

To avoid possible trouble from oscillation at very high and low frequencies the value of the feedback factor should not exceed a certain maximum dependant on circumstances. The trouble arises from the fact that some phase shift occurs at each stage of amplification and in the output transformer, this phase shift being greater at high and low frequencies, so that the feedback may become positive at these ends of the scale. To ensure stability the following general rules should be obeyed:—

- (a) Do not feed back over more than one transformer.
- (b) An interstage transformer should have a resistance shunted across the secondary.
- (c) The feedback factor for a loop covering output transformer and two stages should not be greater than 10.
- (d) Feedback should not be applied over more than three stages plus output transformer, and the maximum value for the

feedback factor in this case is 5. These figures apply to the average amplifier and may be greatly exceeded in specialized

Example 6. An amplifier has a gain of 120 which is to be reduced to 30 by feedback. Find the required value of β and the ratio of the resistances needed.

$$\beta = \frac{120 - 30}{120 \times 30} = \frac{1}{40}$$

i.e., $\frac{r}{R + r} = \frac{1}{40}$ so that $\frac{r}{R} = \frac{1}{39}$

Output Resistance

Another result produced by voltage feedback is the reduction of the apparent output resistance of the last stage. The actual resistance of the valve does not alter, of course, but feedback acts in such a way as to make it appear to the output circuit, which is the loudspeaker, that the valve has a much lower anode resistance. This improves the loudspeaker damping in a manner which is most noticeable in the case of pentodes where the anode resistance is high. When voltage feedback is used the apparent output resistance is

$$R_0 = \frac{r_A}{1 + \mu a b} \dots \dots (10)$$

where r_A = anode resistance of output valve
 μ = amplification factor of output valve
 a = normal gain, without feedback, up to grid of output valve
 b = fraction of output voltage fed back.

When feeding back from the anode of the output valve, b is the same as β in our other formulae and is given by the ratio $\frac{r}{R + r}$ as before.

Example 7. Find the output resistance of a PX25 when used in the circuit shown in Fig. 6. The valve constants for the MH4 are $\mu = 40$, $r_A = 11,100 \Omega$. Since the bias capacitor of the first stage is omitted current feedback takes place, so that we must use equation (3) to find the gain up to the PX25 grid.

i.e.,

$$a = \frac{40 \times 100,000}{41 \times 750 + 11,100 + 100,000} \approx 28.$$

$$b = \frac{750}{33,000 + 750}$$

using equation (7).
 For a PX25, $\mu = 9.5$, $r_A =$

$1,265 \Omega$, so that the output resistance,

$$R_0 = \frac{1,265}{1 + 9.5 \times 28 \times \frac{1}{45}} \approx 183 \Omega.$$

When feedback is taken from the output transformer secondary, the output voltage is already reduced by the transformer ratio and this must be taken into consideration. In the last example, if the feedback had been taken from the secondary of an output transformer of ratio 14 : 1 then the value of b would be given

$$\text{by } b = \frac{1}{14} \cdot \frac{750}{33,000 + 750} = \frac{1}{14} \times \frac{1}{45} = \frac{1}{630}$$

Cathode-Follower Output Stage

The cathode-follower output stage is a special case of feedback. Here the load is placed in the cathode circuit so that all the output voltage is fed back giving $\beta = 1$ in this stage. The feedback factor is thus $1 + A$, where A is the normal gain of the valve. The gain now becomes $\frac{A}{1 + A}$, which means that the stage gives no gain, but a slight loss. The grid input voltage must therefore be increased by $(1 + A)$ times so as to make up for the loss of gain in the output valve.

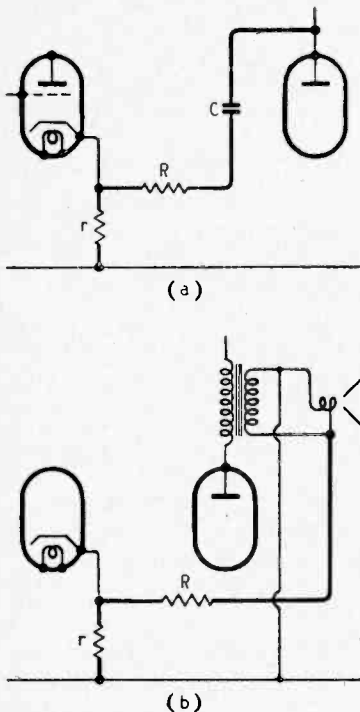

Fig. 5. Voltage feedback from the output transformer primary (a) and secondary (b).

designs such as the Quality Amplifier described in the May issue of *Wireless World*. In this circuit a carefully-designed output transformer and the use of direct coupling in one stage reduce phase shift to a minimum so that the feedback loop covers four stages and the feedback factor is 10.

The absurdity of feeding back over a tone control stage or one incorporating a volume control might be mentioned here also as it is sometimes overlooked. The feedback will obviously try to cancel the changes in tone or volume one is trying to obtain.

If an amplifier already exists in which a certain reduction in gain is permissible, then the value of β is determined by the size of this reduction fraction. If the original gain is A , which can be reduced to A' by feedback, then the required value of β is $\beta = \frac{A - A'}{AA'}$.. (9)

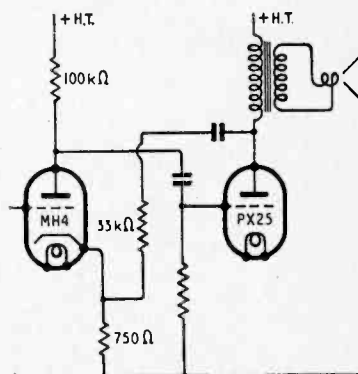

Fig. 6. Two-stage amplifier with voltage feedback.

The output resistance formula (10) now takes the form

$$R_0 = \frac{r_a}{1 + \mu} \dots \dots (10a)$$

since $a = 1$, and $b = 1$. Thus the

Negative Feedback Calculations—
output resistance is reduced by the factor $(1 + \mu)$.

Example 8. A PX25 is used in a cathode-follower output stage. Find the peak input voltage required, and the output resistance. The supply voltage is 440 V. From the manufacturer's data for the PX25, anode voltage 400; $\mu = 9.5$, $r_A = 1,265\Omega$, optimum load

$= 3,200\Omega$, output = 6 W, input = 33 V.

Using equation (5a), the peak voltage across the output load, $V_P = 1.4 \sqrt{6 \times 3,200} = 196$ V.

Notice that here we are using the load at the transformer primary, not the secondary.

The stage gain, $A = \frac{190}{33} \approx 6$.
 \therefore Feedback factor = $1 + A = 7$.

Gain is thus reduced 7 times so that the input must be $33 \times 7 = 231$ V.

The output resistance $R_0 = \frac{1,265}{1 + 9.5} \approx 120\Omega$.

This example emphasizes the one great difficulty of this design, the very large input voltage required at the grid of the output stage.

High-level Detection

AS a result of a "Letter to the Editor" published in *Wireless World* for May, 1948, I have had many requests for further information. In that letter I dealt with the use of a diode detector, operated as high up on its characteristic as possible, feeding directly into a push-pull output stage.

My present set puts these principles into practice. As shown in the diagram, it comprises three low-gain R.F. stages with pre-set tuned transformers and one semi-periodic coupling feeding a high-voltage diode. This acts as phase splitter and feeds two push-pull output valves through resistance couplings. A wide frequency response is obtained by staggering

Quality Receiver Without A.F. Stage

By W. MacLANACHAN

Values of Components			
C1, 2, 4, 5, 16, 17	0.1 μ F	R1, 5	10k Ω
C3	0.15 μ F	R2, 6	27k Ω
C6, 9	0.25 μ F	R3	400 Ω
C7, 10, 18	1 μ F	R4, 22, 24	4.7k Ω
C8	0.5 μ F	R7	500 Ω
C11, 12, 14, 15	0.0001 μ F	R8	3k Ω
C13	16 μ F	R9, 15	1k Ω
Valves: V1,2, SP61; V3, KT61; V4, D63; V5, 6, PX25.		R10, 13, 26, 27	150 Ω
		R11	1.5k Ω
		R12	90 Ω
		R14, 21, 25	50k Ω
		R16, 18, 19	15k Ω
		R17	7.5k Ω
		R20, 23	100k Ω
Anode and screen resistors are 1W, all others are $\frac{1}{2}$ W except R14, R16 and R17, which are actually 12W.			

of maintaining the correct relationship between it and the grid leaks of the PX25s, must deal with a

The PX25s are biased to their correct operating point with maximum voltage on the anodes. Nega-

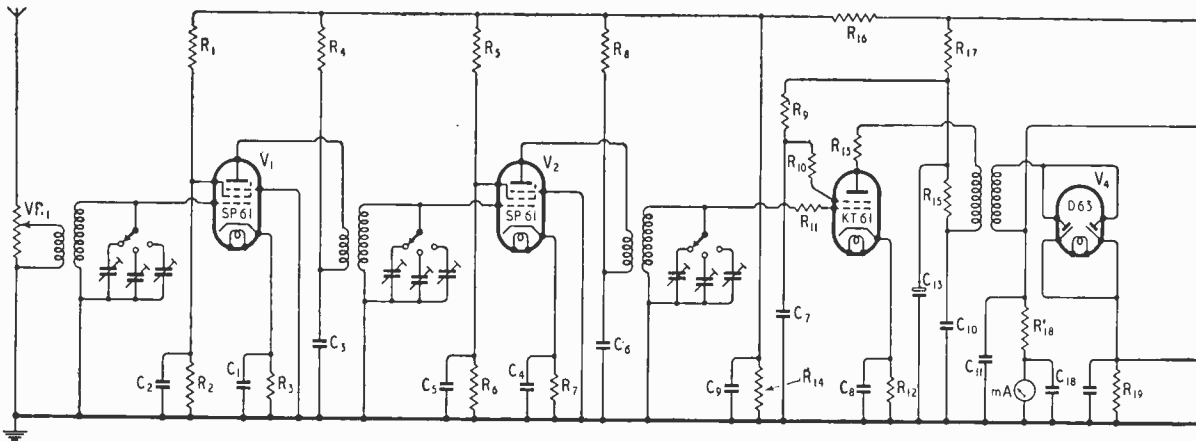

the R.F. tuned circuits, which incidentally assists in stability. To load fully the PX25s in the output stage the diode has to handle inputs up to about 120V R.F. and, as the load resistance has to be of low value because of the necessity

Circuit diagram of the receiver, in which a diode detector feeds the push-pull output stage without intermediate amplification.

comparatively heavy current. Fortunately the D63, with anodes and cathodes in parallel, can stand up to 4mA.

tive feed-back is taken from an extra secondary winding on the special Partridge output transformer and is fed to the grid cir-

cuits by tapping on the grid-leaks.

The main trouble in a set of this type is R.F. instability. With such a large output from V₃ almost complete screening of the leads is necessary, but, owing to the need for adequate ventilation of the valve (a KT61 output tetrode) only a two-sided screen is used between the valve and the remainder of the set. Grid, screen, and anode stabilising resistances were included in the leads to the valve-holder. The first two valves are SP61s (VR65), which have separately earthed metallising.

The coupling between the KT61 and the D63 is untuned with a very flat characteristic, and is actually the L.W. portion of an R.F. transformer. It is totally screened and the leads to the diode are also enclosed in metallized sleeving.

The aerial and first two R.F. transformers are home-made, but in another unit which has proved satisfactory for the same purpose Wearite M.W. transformers are used with damping resistances of from 20 to 40 kilohms across the secondaries. The unit used for the modification is one of the R.A.F. RF24 and 25, widely available as Government surplus. As these units contain three VR65s and many of them have only one easily screened hole for the switch spindle between the compartments they lend themselves admirably for

500-0-500V at 180mA, 4V at 3A for the U18/20 rectifier, 6V at 4-5A for the R.F. stages, and two 4V 2A windings for the PX25s. It is preferable to have a separate 6V, 0.3A winding for the D63. The windings, naturally, depend on the types of valves chosen or available. Smoothing is by choke filter with 4-μF condensers.

Practically all the components are Government surplus, as may be seen from the values of the resistances actually used. Some latitude can be allowed in most of the circuits except in the A.F. couplings.

One refinement incorporated is a 10mA meter connected at the low-potential end of one of the halves of the diode load resistor and bypassed by a high value capacitor. This not only indicates the voltage across the 30-kΩ load (30V per mA), but also assists in the staggering of the tuned circuits.

BOOK REVIEW

Principles of Radar. By Denis Taylor, Ph.D. and C. H. Westcott, Ph.D. Pp. 141 + x, with 52 figures and 5 plates. Cambridge University Press, 200, Euston Road, London, N.W.1. Price 12s 6d.

THE authors' background in T.R.E. provided an unusually favourable combination for the purpose of a book such as this; it was authoritative, it was practical, and at the same time it was an important teaching centre. So it is not surprising that the book is accurate, clear and specific. Some of the books that have been published on the subject are so detailed that the reader is likely to miss the wood for the trees; this one keeps firmly to essentials and does not get entangled in a maze of engineering and circuitry. References are given to detailed treatment in *Journal I.E.E.*, Part IIIA and elsewhere.

The disadvantage of the background is that the examples are drawn preponderantly from systems developed at T.R.E.; and especially the metre-wave types which had little or no future even in 1945. Among wartime systems, the rocket-detecting and proximity-fuse radars, which might be expected to have most post-war military significance, are not mentioned; and ship-borne radar, which is the most important at the present day, is summarily dismissed.

This backward-looking tendency is regrettable in an otherwise excellent book, because much of the space

devoted to historical types might more profitably have been used to bring out the tendencies most likely to be prominent in post-war developments.

Nevertheless, matters such as noise factor, perception factor, aerial gain and equivalent area, which determine performance, are clearly and concisely explained, and illustrated by numerical examples. The measurement of range, azimuth and elevation is discussed in three chapters, and a fourth is devoted to systems in which measurement of azimuth and elevation are combined. The radar properties of targets, and their separation from unwanted echoes, are considered more thoroughly than usual. Except for the last chapter, on secondary or responder systems, "radar" is confined to its strict sense, involving echoes.

It cannot be denied that the terms "radar" and "radiolocation" have been, as the authors say, interchangeable; but seeing that "radiolocation" was never used by those closely concerned with radar (or R.D.F.) it is a pity that there is not more support for the proposal made by the present Chairman of the I.E.E. Radio Section in his Address, that "radiolocation" should be used, in distinction from "radiocommunication," to refer to all systems of location by radio, of which radar is one.

With regard to terms, it should be noted that "V.E.B.," hitherto confined to a 200-Mc/s system, is used by the authors to cover all variable-elevation-beam systems, such as C.M.H. And that the Hertzian dipole mentioned on p. 26 is not the common dipole referred to elsewhere. Some readers, too, might not realize that receiver "output" noise or signal, involved in noise factor, must be measured before the detector.

M. G. S.

Books Received

Radio Receivers and Transmitters.

By S. W. Amos and F. W. Kellaway (second edition; first edition reviewed in *Wireless World*, Feb., 1945). Deals with principles and practice, the aim being to provide a link between pure science and applied radio. This edition includes extra material on negative feedback, microphones and grid detection. Pp. 356; 210 figures. Chapman and Hall, 37, Essex Street, London, W.C.2. Price 25s.

Second Year Radio Technology. By W. H. Date. Written for engineering students who have already acquired a basic knowledge of electricity and magnetism. The book covers the syllabus of City and Guilds radio communication examination Grade 1. Pp. 222; 155 figures. Longmans, Green and Company, 43, Albert Road, London, S.W.19. Price 7s 6d.

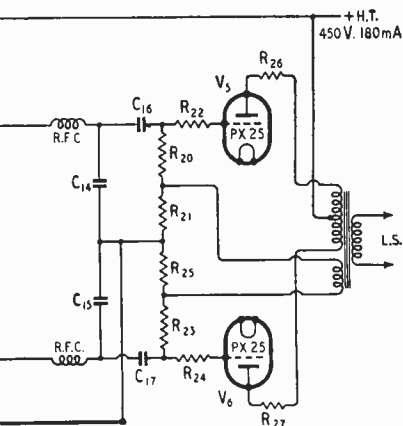

adaptation for high-level detection, but part of the case must be cut away for ventilation of V₃.

The circuit diagram omits such unessential features as heaters and mains equipment. This latter consists of a mains transformer giving

Series Capacitor Heater Circuits

Negligible Power Loss and Better Regulation

By A. W. STANLEY

TWO ways of supplying valve heaters with power from the mains are shown in Fig. 1. The more usual method using a series resistor is shown in (a) and an alternative method using a series capacitor in (b). It is the purpose of this article to compare the performance of these two circuits, particularly with regard to their regulation, and to deduce graphical methods of determining the values of R and C to suit particular circuits.

Perhaps the most obvious difference between the circuits is that (a) will operate equally well from A.C. or D.C. mains whereas (b) can only be used on A.C. mains. But (b) has the advantage over (a) that there is no power waste in the capacitor and the only power taken from the source is that required by the heaters. Circuit (b) is thus more economical than (a), in which the power wasted in the series resistor sometimes exceeds that supplied to the heaters. Another advantage of (b) is that the regulation is better; i.e., the change in current caused by a given change in heater resistance is less in (b) than in (a).

A property of the series capacitor circuit is that the valve heaters warm up under practically constant current conditions and there is no prolonged initial surge of current as with a series resistor. Thus the time taken for the heaters to reach the working temperature is longer in (b) than in (a). To offset this disadvantage of (b), however, there is less risk of burning out dial lights when these are connected in series with the heaters. After a circuit such as (b) is switched on, the dial lights gradually attain their full brilliance, taking several seconds in the process. In (a), after switching on, there is usually a brief period when the heater current is greater than normal;

whilst this is useful in accelerating the warming-up process it has the disadvantage that the life of the dial lights, and perhaps the valves too, is shortened.

In circuit (b) the heaters should be protected from damage in the event of a short-circuit in the capacitor by the inclusion of fuses in the circuit. The resistor indicated in dotted lines in (b) has a very high value, such as 1 MΩ, and plays no part in feeding the heaters: it discharges the capacitor when the heater circuit is disconnected from the mains

amplifier take 0.2 A and the voltage ratings of the heaters total 100 volts, Fig. 2 shows that the series resistor should be 650 Ω.

The slope of the curves in Fig. 2 gives an measure of the regulation of the circuit and the fact that the curves are all straight and have the same slope at all points shows that the regulation is no better with a small series resistor than with a large one. Because of the power wasted in a large series resistor it is best to aim at securing as small a value of R as possible.

An expression for the regulation of the circuit can be obtained by differentiating the expression for I_H in Fig. 1(a) with respect to R_H

$$I_H = \frac{V_{min}}{R + R_H} \quad \dots \quad (2)$$

where R_H is the total resistance of all the heaters, when hot, and is assumed constant.

From (2)

$$\frac{\delta I_H}{\delta R_H} = - \frac{V_M}{(R + R_H)^2} \\ = - \frac{V_M}{R^2_{total}} \quad \dots \quad (3)$$

This result shows that the change in current for a given change in heater resistance depends only on the mains voltage and the resistance, R_{total} , of the circuit. To illustrate this by a numerical example, let $V_M = 230$ volts, $I_H = 0.2$ A and $V_H = 100$ volts. As shown above the series resistor is 650 Ω and the total resistance is 1150 Ω. Now suppose that an additional valve, of heater resistance 50 Ω when hot, is inserted in the circuit. From (3) the change in heater current per ohm change in heater resistance is given by $230/1150^2$ A and the change for 50 Ω resistance is hence $230 \times 50/1150^2 = 0.0087$ A. The new heater current is thus roughly 4.5 per cent low.

The capacitance needed in cir-

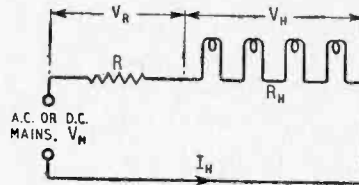

(a) SERIES RESISTOR CIRCUIT

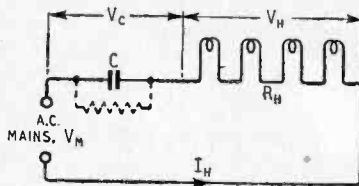

(b) SERIES CAPACITOR CIRCUIT

Fig. 1. Methods of feeding heaters from the mains.

and prevents shocks being obtained from the mains plug.

In Fig. 1(a) $V_R = V_M - V_H$ and hence, $R = \frac{V_M - V_H}{I_H} \quad \dots \quad (1)$

This expression is plotted in Fig 2 for $V_M = 230$ volts and for five values of I_H between 0.1 and 0.3 A. This diagram is useful for determining the values of series resistors or line cords to use in particular circuits. For example if the heaters in a receiver or

cuit (b) may be calculated in the following way. The p.d. across C is given by

$$V_C = \sqrt{V_M^2 - V_H^2} \dots (4)$$

and since I_H is the current in the capacitor

$$I_H X_C = V_C \dots (5)$$

where X_C is the reactance of the

The low slope of the curves in Fig. 3 at low values of V_H implies that there is some latitude in the value of C corresponding to a given value of V_H . From this it follows that a particular value of C will be suitable for an appreciable range of values of V_H i.e., the

also because large values of C are necessary at these values of V_H , it is recommended that V_H be kept as small as possible. For example is $V_H = 180$ volts and $I_H = 0.2A$ in a particular circuit, it might be preferable to arrange the heaters in a series-parallel combination for which $V_H = 90$ volts and $I_H = 0.4A$. The capacitance necessary would be $6\mu F$, double that necessary when $V_H = 90$ volts and $I_H = 0.2A$.

The current in the circuit of Fig. 1(b) is given by

$$I_H = \frac{V_M}{\sqrt{R_H^2 + X_C^2}}$$

and from this the regulation of the circuit is expressed by

$$\frac{\delta I_H}{\delta R_H} = \frac{V_M R_H}{(R_H^2 + X_C^2)^{3/2}} = - \frac{V_M R_H}{Z^3} \dots (7)$$

where Z is the impedance of the circuit and equals $\sqrt{R_H^2 + X_C^2}$. For a given value of V_M the regulation depends on the value of R_H , and the change in I_H for a given change in R_H is less when R_H is small than when R_H is large this agreeing with the conclusions drawn from the curves of Fig. 3.

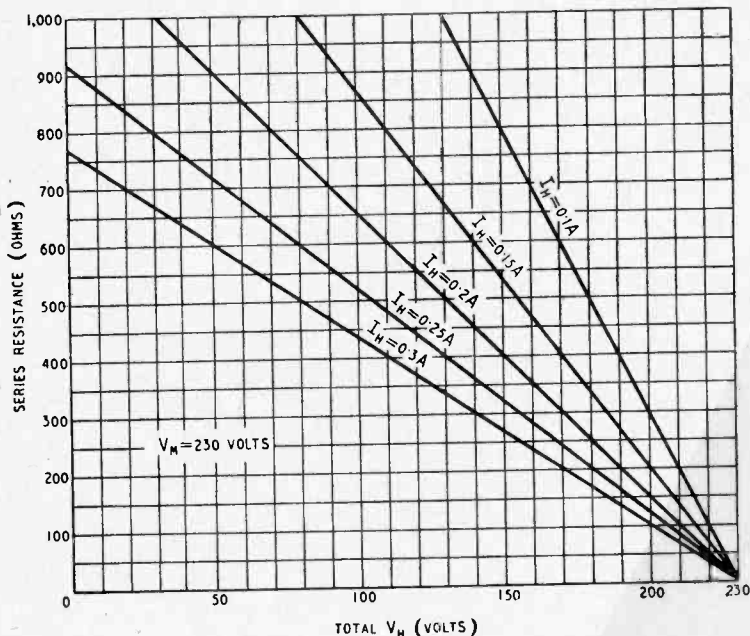

Fig. 2. Graph for determining values of R in Fig. 1 (a).

capacitor at the mains frequency. Combining (4) and (5)

$$X_C = \frac{V_C}{I_H} = \frac{\sqrt{V_M^2 - V_H^2}}{I_H}$$

Since $X_C = 1/2\pi fC$ the final expression for C is

$$C = \frac{I_H}{2\pi f \sqrt{V_M^2 - V_H^2}} \dots (6)$$

In Fig. 3 values of C are plotted against V_H for values of I_H between 0.1 and 0.3A, V_M and f being taken as 230 volts and 50 c/s respectively.

As an example of the use of Fig. 3, suppose the heaters consume 0.2A and that the voltage ratings of the heaters total 90 volts. From Fig. 3 the series capacitor should be $3\mu F$. The p.d. across the capacitor is $\sqrt{230^2 - 90^2} = 212$ volts R.M.S., roughly 300 volts peak, practically equal to the full mains voltage. The capacitor should thus have a working rating appreciably greater than 300 volts.

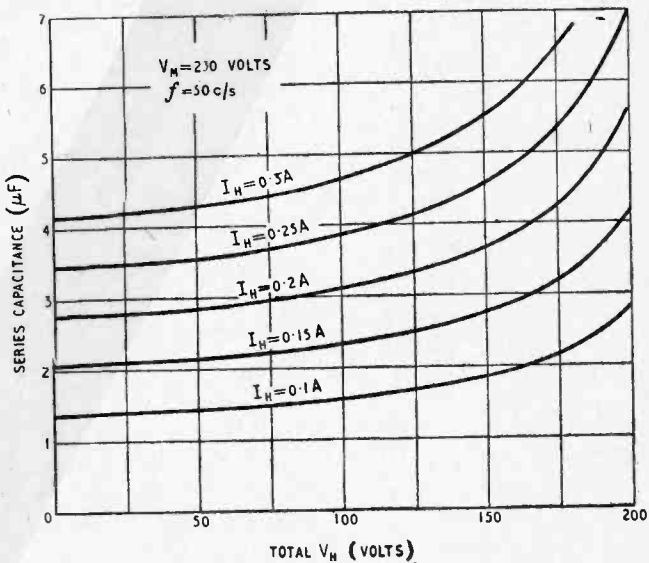

Fig. 3. Graph for determining values of C in Fig. 1 (b).

regulation is good. The regulation gets poorer, however, as the value of V_H approaches the mains voltage and for this reason, and

In this respect the behaviour of circuit (b) differs considerably from that of circuit (a). This can be illustrated by repeating the

Series Capacitor Heater Circuits— calculation made above assuming, this time, that a series capacitor is used.

If $V_M = 230$ volts, $I_H = 0.2$ A and $V_H = 100$ volts C is just over $3\mu\text{F}$ and Z is 1150Ω . Substitution in (7) shows that the change in heater current per ohm change in heater resistance is given by $230 \times 100 / 1150^3$ A and the change in current brought about by inserting an additional valve of 50Ω resistance is hence $230 \times 100 \times 50 / 1150^3 = 0.000756$ A. Thus the new heater current is less than 0.4 per cent. low, whereas with the series resistor it was roughly 4.5 per cent. low. For these values of V_M , V_H and R_H the regulation of circuit (b) is

more than 10 times better than that of circuit (a). By dividing (3) by (7) and remembering that Z and R are numerically equal for equal mains voltages and equal heater currents, it is seen that, in general, the regulation of the series capacitor

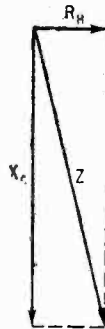

Fig. 4. Vector impedance diagram for the circuit of Fig. 1 (b).

circuit is Z/R_H times better than that of the series resistor circuit. In the example $Z = 1150\Omega$ and R_H

$= 100\Omega$ and thus the regulation of circuit (b) is 11.5 times better than that of circuit (a), thus confirming the numerical results obtained.

The reason for the superior regulation of (b) is easy to see from a vector diagram of impedance. In circuit (a) any change in R_H causes an equal change in R total and the new heater current is inversely proportional to R_{total} . In circuit (b) the current is inversely proportional to Z and Z is obtained by vectorial addition of R_H and X_C as illustrated in Fig. 4. From this it can be seen that if R_H is small compared with X_C , any change in the value of R_H causes only a very small change in Z and hence in the heater current.

Short-wave Conditions

July in Retrospect: Forecast for September

By T. W. Bennington and L. J. Pechner (Engineering Division, B.B.C.)

DURING July the average maximum usable frequencies for these latitudes decreased somewhat during the day and night instead of remaining at about the same level as in June in accordance with the seasonal trend. This may have been due to lower sunspot activity as compared with June. There was very little difference between the day and night values of M.U.F.s.

Communication on frequencies higher than 35 Mc/s was very infrequent, although regular contact was maintained with South America and South Africa on the 28-Mc/s band. Signals from the South Pacific area have been also received on that band on one or two occasions. Frequencies below 14 Mc/s for distances exceeding 3,000 miles were not practicable at night and conditions on the lower frequencies were still poor.

The rate of incidence of Sporadic E was very high, in accordance with the seasonal trend, and, as in June, many contacts were made with the Continent, as, for example, with Scandinavia and Italy. Long-range tropospheric propagation was again observed, reception of frequencies as high as 58 Mc/s being reported by amateurs quite frequently during the spell of fine weather even at distances of the order of 200 miles.

Sunspot activity in July was less than in June, but two moderately large groups were observed, which crossed the central meridian of the

sun on 11th and 26th. On the whole, July was a quiet month, and, although ionosphere storms occurred on 1st, 6th, 10th-11th, 14th-17th and 31st, none of them was very severe.

Relatively few Dellinger fadeouts have been observed, but those recorded on 29th were fairly severe.

Forecast.—In September the seasonal effect in the Northern Hemisphere is such as usually to cause a considerable increase in the daytime M.U.F.s and a slight decrease in the night-time M.U.F.s.

Daytime working frequencies for long-distance transmission paths should, therefore, be much higher than in August and, for example, the 28-Mc/s band should be usable in far more directions and for longer periods than in August. Frequencies as high as 17 Mc/s should remain practicable till after midnight on many circuits and those below 11 Mc/s should seldom be necessary at any time during the night.

The E and F₁ control of transmission over medium distances should be much less marked than during the past few months, and extend to only an hour or two around noon.

Sporadic E usually occurs less often in September, and not much communication over medium distances is likely to take place by way of this region as compared with August.

Below are given, in terms of the broadcast bands, the working fre-

quencies which should be regularly usable during September for four long-distance circuits running in different directions from this country. (All times G.M.T.) In addition, a figure in brackets is given for the use of those whose primary interest is the exploitation of certain frequency bands, and this indicates the highest frequency likely to be usable for about 25 per cent of the time during the month for communication by way of the regular layers:—

Montreal :	0000	11 Mc/s	(18 Mc/s)
	0100	9 "	(15 ")
	0900	11 "	(17 ")
	1100	15 "	(22 ")
	1200	17 "	(26 ")
	2000	15 "	(22 ")
Buenos Aires :	0000	15 Mc/s	(23 Mc/s)
	0100	11 "	(19 ")
	0800	15 "	(23 ")
	0900	17 "	(28 ")
	1000	21 "	(33 ")
	1200	26 "	(35 ")
Cape Town :	0000	15 Mc/s	(23 Mc/s)
	0200	11 "	(19 ")
	0500	15 "	(21 ")
	0600	17 "	(28 ")
	0700	21 "	(37 ")
	0800	26 "	(41 ")
Chungking :	0000	9 Mc/s	(15 Mc/s)
	0500	11 "	(18 ")
	0800	15 "	(24 ")
	0700	17 "	(27 ")
	1600	15 "	(20 ")
	1800	11 "	(17 ")
	2100	9 "	(15 ")

There is often an increase in ionosphere storminess in September, and periods of poor short-wave communication may occur at times. At the time of writing it would appear that disturbances are more likely to take place during the periods 1st/2nd, 4th/6th, 18th/20th and 23rd/25th than on the other days of the month.

WORLD OF WIRELESS

Overseas B.B.C. ♦ Two-Metre Amateurs ♦ British Components in Sweden

B.B.C. IN THE FAR EAST

FOR some time it has been known that negotiations were being made for the B.B.C. to take over the station in Singapore which has, since the end of the war, been operated by the British Far Eastern Broadcasting Service under the auspices of the Foreign Office.

The B.B.C. has, at the request of the Government, now assumed responsibility for the service which is radiated by a 7.5-kW transmitter operating on 6.770, 9.690, 11.730, 15.300 and 21.720 Mc/s.

It is stated in the lay press that this is the first time the B.B.C. has operated a station outside the U.K. It has been forgotten that one of the transmitters used for the B.B.C. European Service is in Germany—at Norden, operating on 658 kc/s.

NEW NORWICH STATION

A SITE has been chosen for a new B.B.C. transmitter near Norwich, and the construction of the station has begun.

This new 5-kW station, which will supersede the existing one-kW transmitter in Norwich, will radiate the Midland Home Service on 1013 kc/s (206.2 m). The site is $4\frac{1}{2}$ miles east of Norwich, on the Acle - Great Yarmouth road. A directional aerial system will be used consisting of two mast radiators, each 126ft high. It is understood the transmitter is being built

from equipment which was in stock in the Engineering Dept.

It is not yet possible to give the date on which the station will come into service.

NEW AMATEUR BAND

AMONG a number of additional bands allocated to amateurs at the Atlantic City international conference was that of 144-146 Mc/s. Although the provisions of the convention have not yet come into force the G.P.O. has notified British amateurs that from Sept. 1st they may operate in the top half of this band—145-146 Mc/s. Operation on both 'phone and key is limited to 25 watts input to the last valve.

In the Atlantic City allocations the band (144-146 Mc/s) is for the exclusive use of amateurs throughout the world, but at the moment, in this country, some "vital services" are operating in the lower half.

It was rumoured that the 420-460 Mc/s band was also to be made available but, according to the R.S.G.B., negotiations are still proceeding.

INTERNATIONAL TELEVISION

THREE of the eleven main lectures to be given at the forthcoming International Television Conference to be held in Zurich will be given by British engineers.

The conference, organized by the

Swiss National Television Committee and the Swiss Federal Institute of Technology, will be held from September 6th to 10th. The British contributions will be on "Studio and O.B. Television Practice in Great Britain," by T. H. Bridgewater (B.B.C.); "Distribution Network for Television Signals," by D. C. Espley (G.E.C.); and "Certain Aspects of Circuit Design in Television Transmission," by T. C. Nuttal (Cinema-Television). Dr. Zworykin (U.S.A.) will deal with electronics in television and R. Barthelemy (France) with the international aspects of television.

All papers read at the conference will be reprinted in the *Bulletin de l'Association suisse des electriciens*.

R.C.M.F. STOCKHOLM SHOW

A PRIVATE exhibition of British radio components and test gear is being organized by the Radio Component Manufacturers' Association in the Kungshallen, Kungsgatan, Stockholm, Sweden, from October 18th to 22nd.

The exhibition, which is promoted with the object of acquainting radio and electronic manufacturers and engineers with the most recent advances in the design and development of British components and accessories and in the materials employed in their manufacture, will be open to visitors bearing invitation cards. These are obtainable by bona fide manufacturers and engineers from the Radio Component Manufacturers' Federation, 22, Surrey Street, Strand, London, W.C.2.

R.S.G.B. TRANSMITTER

THE headquarters station of the R.S.G.B., which it was anticipated would be radiating early this year, will start operating as a

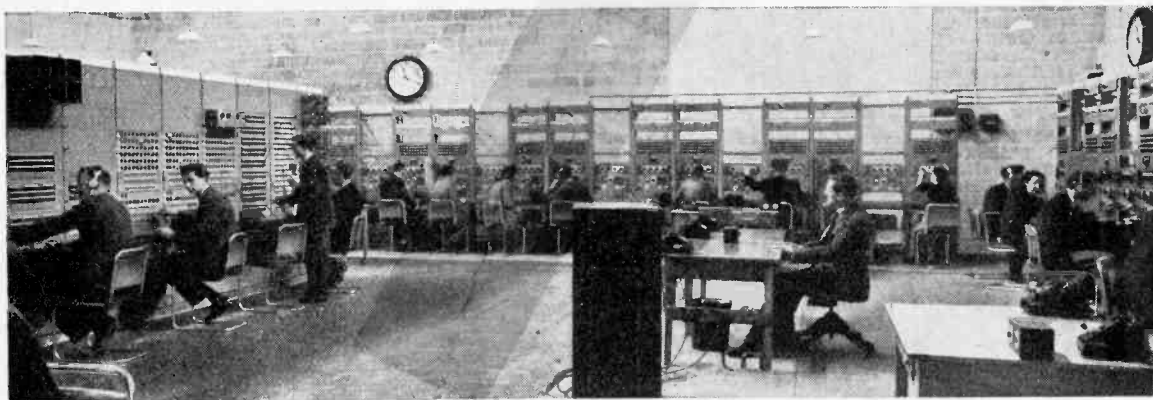

NERVE CENTRE. Part of the central control room set up by the B.B.C. at Wembley for the Olympic Games. Lines from the 121 microphone points at the various centres where events were held converged on this point. The Wembley radio centre included eight studios each equipped with twin gramophone turntables, twenty disc recorders and twelve mobile recording cars.

World of Wireless—

frequency marker on 3500.25 kc/s at 8 p.m., on September 1st. Thereafter the station, GBIRS, will radiate a short automatically transmitted message at 12 w.p.m. during the first two minutes of each hour from 0600 to 2400.

The 300-watt transmitter, which can be operated on any frequency between 1.5 and 20 Mc/s, was presented to the society by E.M.I. some time ago.

P.T. ON RECORDS

GRAMOPHONE records of a kind not produced in quantity for general sale are now exempt from Purchase Tax. The exemption includes: records produced without a matrix, that is "direct recordings"; records produced from a matrix in cases where not more than 100 pressings will be made; and those made for a single client or organization in which the copyright will be retained by them. The Order is entitled "The Purchase Tax (No. 2) Order, 1948," and came into operation on August 10th.

OBITUARY

It is with regret we record that

Sir Clifford Paterson, O.B.E., D.Sc., F.R.S., died on July 26th at the age of 68 after a short illness. He joined the G.E.C. in 1919 to establish and direct the company's research laboratories, which started with a staff of 29 and now has one of 1,750. Sir Clifford, who was past president of both the I.E.E. and the Institute of Physics, was appointed to the Board of the G.E.C. in 1941 and received his knighthood in 1946. Prior to joining the G.E.C. he was at the National Physical Laboratory. He had recently returned from a visit to Australia.

S. G. Brown, F.R.S., died on August 7th, aged 75. He was, until 1941, chairman of S. G. Brown, Ltd., which he founded, and the Telegraph Condenser Co. It was in 1910 that he patented his reed telephone earpiece, and ten years later that his loudspeaking telephone was produced. Writing



The late S. G. BROWN, F.R.S.

U.S.W. provided two-way communication between officials in a launch and those on shore during the recent Maidenhead Regatta. Special permission was obtained from the P.M.G. to use 465 Mc/s, with a power of 0.5 W. Col. P. Northey (G6FQ) and two fellow R.S.G.B. members provided the gear.



of this in *Wireless World* in February, 1921, a contributor stated "The pattern of 'loud speaker' most often found in use . . . is that manufactured by S. G. Brown." It was not only in this field that his inventive genius was displayed. His patents include the gyroscopic compass, peroxide of lead detector, a C.W. generator, microphone relays, etc.

Alex Moody died on August 1st at the age of 62. He was best known in the radio industry as the organizer of every national radio exhibition since 1928.

PERSONALITIES

Sir Stanley Angwin, chairman of Cable and Wireless, is to act as consultant and adviser on research and development to the Board of Marconi's W.T. Co.

W. E. Miller, M.A., Editor of our associated journal, *The Wireless and Electrical Trader*, has been nominated as a vice-president of the British Institution of Radio Engineers. He has been a member of the Institution for over twenty years and has been chairman of the council for the past two years.

Robert Tanner, who left the B.B.C. Research Dept. last year and went to Canada, has been appointed audio equipment engineer in the Northern Electric Co., of Belleville, Ontario.

IN BRIEF

Licences.—At the end of June the approximate number of broadcast receiving licences in force in Gt. Britain and N. Ireland was 11,290,350. This number includes 54,857 television licences, an increase of 2,350 in the month.

"Navigation through the Ages" is to be the title of an exhibition to be held at the end of the year by the Institute of Navigation in conjunction with the Royal Geographical Society. It will be opened at the Royal Geographical Society on December 17th at 4.30. A lecture on radar navigation will be given by Sir Robert Watson-Watt at 5.0. It will be open to the public, and further particulars are obtainable from the Institute, 1, Kensington Gore, London, S.W.7.

New Zealand.—Twenty-one of New Zealand's twenty-three medium-wave broadcasting stations will change their wavelengths, and in some cases their call signs, on September 1st. The changes in frequency have been found necessary to avoid interference between N.Z. and Australian stations. Coincident with these changes five new transmitters will be brought into service. At present the Dominion has eighteen national and five commercial broadcasting stations, all of which are operated by the New Zealand National Broadcasting Service.

Business Radio.—It is learned from the G.P.O. that approx. 110 licences have now been issued to operators of "business radio" transmitters. A recent application of "business radio" was the shepherding through London of a convoy of lorries carrying an exceptionally bulky load of scaffolding for the Olympic Games. The manufacturers, Scaffolding (Great Britain), Ltd., have a fleet of radio-equipped cars and a transmitter at their head office for such occasions.

Noisy Loudspeakers.—A useful part in the anti-noise campaign could be played by the Post Office if it adopted the scheme used in some foreign countries of including an injunction to "turn down the radio" in the cancellation mark on letters. Both the Swiss and Danish authorities have introduced a specially designed cancellation mark. The Danish stamp includes a cartoon showing a disturbed sleeper putting his hands to his ears while musical notes are dancing around the room. The drawing is accompanied by the slogan *Daemp Radioen*. (It means pretty much what you think, reader.)

German Amateurs in the British and American Zones—excluding Berlin—have now been granted transmitting licences.

Last Month's Cover.—In the note on the cover illustration of our August issue reference was made to "the twelve 100-kW Marconi transmitters." This is incorrect: actually six of the transmitters at Skelton were made by Marconi's; the others were supplied by Standard Telephones and Cables.

I.S.W.C. informs us that a special broadcast for S.W. listeners will be radiated by Radio Leopoldville, Belgian Congo, on 9.768 Mc/s at 1900 hrs.

G.M.T. on September 15th and again at 0200 on September 16th.

East London Course.—Provision is made in the prospectus of evening classes sponsored by the Ilford Literary Institute for a radio amateurs' course in preparation for the City and Guilds radio amateurs' exam. The classes will be held at the County High School for Girls, Cranbrook Road, Ilford, on Wednesdays from 7.0-9.0. Enrolments will be taken from September 6th to 9th from 7.0-8.30 p.m. The fee for the session, which is from September 13th to April 8th, is 5s.

Engineering Courses. The 1948-49 prospectus of the Electrical Engineering Department of the Polytechnic, Regent Street, London, W.1, includes a number of evening courses in tele-communications, television and servicing. Enrolment forms and the prospectus are obtainable from the Principal of the Department. Enrolments will be taken on September 15th and 16th from 6.0 to 8.0 p.m.



SUPPRESSED.—Copies of this sticker, prepared by the R.S.G.B., are available gratis from the society at New Ruskin House, Little Russell Street, London, W.C.1.

Ferry Radar.—So that a better ferry service can be provided at Tilbury during foggy weather radar equipment is to be installed at the Riverside Station by the London Midland Region of British Railways.

B.S.R.A.—The lecture season of the British Sound Recording Association commences on September 23rd, when the new president, W. S. Barrell, B.Sc., technical director of E.M.I. Studios, Ltd., will give his presidential address. The meeting will be held at the Royal Society of Arts, John Adam Street, Adelphi, London, W.C.2, at 7.0. The association's new vice-president is M. J. L. Pulling, M.A. (B.B.C.).

I.E.E. Students.—The committee of the London Students' Section of the I.E.E. has appointed the following officers to serve during the 1948-49 session: chairman, A. Mason, B.Sc.; and secretary, D. R. A. Mellis—both S.T.C. men.

matter, has been informed that, "where the apparatus consists of a series of public-address-type units (radio, gramophones, amplifiers, etc.), each in a self-contained, enclosed cabinet, which are stacked vertically without being enclosed in an outer cabinet, such apparatus will only be liable to Purchase Tax in respect of the gramophone and wireless receiving units." The proviso is added that this will apply when such apparatus is put up solely for public address use.

Plessey-Bendix Agreement.—Mobile, ground and aircraft radio-communication equipment and navigational aids designed by the Bendix Corp. of America are to be produced in this country by the Plessey Co.

A.C./D.C. Television Tubes.—The 9-in C.R. tube used in the Pye transformerless television receiver, described on the next page, is the new Mullard MW22/14, with a 6.3-V, 0.3-A heater for running in series with the valves. It has an external conducting coating on the flare for use as a capacitor for E.H.T. smoothing. Similar 9- and 12-in tubes without this coating are available.

A Quarterly Journal, "Murex Review," is to be issued by Murex, Ltd., Rainham, Essex, and will deal with matters of interest to users of the rarer metallurgical products. Among the firm's products are tungsten, molybdenum, sintering powders and other raw materials used in the radio industry.

Morganite Resistors.—The new 90,000-sq ft factory of Morganite Resistors, Ltd., at Jarrow, was opened by the President of the Board of Trade last month. The company is a recently formed subsidiary of the Morgan Crucible Company.

R.G.D.—The London depot and export department of R.G.D. is now at

at 245, Brixton Road, London, S.W.9 (Tel.: Brixton 3550), where enquiries regarding service and spares for Nagard oscillographs should be made.

EXPORT

B.o.T. Report.—In the Board of Trade summary of exports for the second quarter of the year reference is made to a slight recovery in the export of sets from the low level reached in the first quarter. The value of domestic receivers exported during the half year was £1,978,880 compared with £2,245,511 in the same period last year. The countries showing the most marked decreases in their importations of receivers are Palestine (£43,000 compared with £171,000), India and Pakistan (£209,000, £230,000) and Iran (£36,000; £198,000).

Magnetic Tape.—The U.K. Trade Commissioner in Vancouver has been asked if he can put an engineer in touch with a source of supply of paper or plastic magnetic sound-recording tape. The tape required is 0.248in wide with a plastic or, preferably, paper backing, supplied on a standard 7in diameter 8mm motion-picture reel carrying 1,225 feet of tape to give 30 minutes of recording at a speed of 7.5in per second. A sample of tape similar to that required is available for inspection in Room 1111, Export Promotion Dept., Thames House North, Millbank, S.W.1. (Tel.: Victoria 9040, Extn. 3135.) Firms interested in the enquiry are requested to write direct to F. Sawford, 641, Granville Street, Vancouver, B.C., enclosing samples and giving full particulars.

N. and S. Rhodesia.—Owing to currency restrictions, which preclude importations from dollar areas, distributors in the Rhodesias are anxious to learn of British sources of supply for

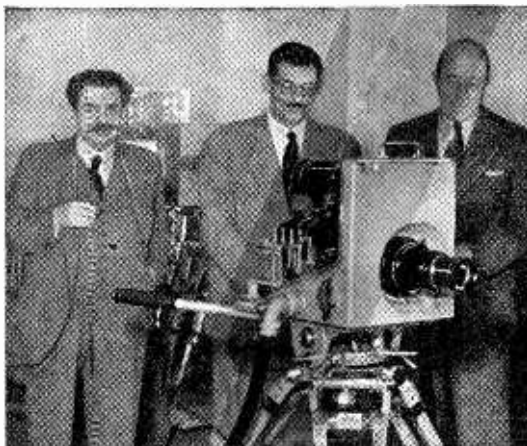

ARGENTINE TELEVISION.—H. E. Ing. Don Juan Jose Vistalli technical adviser to the presidential committee for the Argentine five-year plan, inspecting an experimental E. M. I. television camera. With him are, right, Sir Ernest Fisk and I. Shoenberg. 620-line television gear was demonstrated to His Excellency during his visit to Hayes.

INDUSTRIAL NEWS

P.T. on P.A. Gear.—The ruling providing for Purchase Tax at 66 2/3 per cent to be charged on the whole equipment when a gramophone is housed in the same cabinet as the amplifier has now been amended. The Electronic Manufacturers' Association, which made representations on this

3-4, Hampton Court Parade, East Molesey, Surrey. (Tel.: Molesey 4357-8.) Nagard, Ltd., is the name of the new company taking over the manufacturing and research activities of the International Television Corporation, of 102, Terminal House, Grosvenor Gardens, London, S.W.1. The new company's works and laboratories are

the following: car receivers (6- and 12-V, 10-550 metres), domestic receivers (A.C., all-dry and universal), radio-gramophones, valves, test equipment, hearing aids, and components. Literature and quotations should be sent to H. Polliack and Co., Ltd., Polliacks Building, Eloff Street, Johannesburg. (Continued at foot of next page.)

Transformerless Television Receiver

First "A.C./D.C." Set

DESIGNED on the familiar lines of the A.C./D.C. broadcast receiver, with series-connected valve heaters and a half-wave rectifier for the H.T. supply, the Pye B18T television receiver has no mains transformer. The set is the first on the market in which this technique has been applied to television.

The makers state that the set is designed for use on A.C. mains of 230-250 V, 50 c/s, and that for supplies of 190-220 V an auto-transformer is necessary. They make no mention of the possibility of operating the set from D.C. mains. However, there is no obvious reason why this should not be practicable and, in fact, a model has been seen operating satisfactorily from a 240-V D.C. supply. Presumably, however, D.C. operation would be limited to supplies of not less than 230 V.

The advantages of doing away with a mains transformer are chiefly

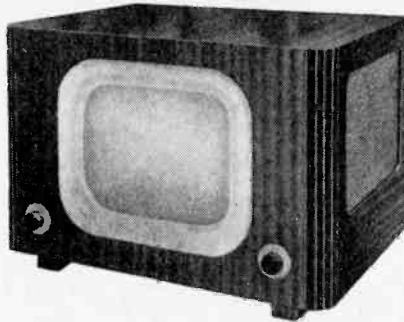

In the B18T table model, the loudspeaker grille is at the side of the cabinet.

the reduced weight and size of the equipment. The dimensions of the set have been brought down to 17½ in wide by 12½ in high by 12½ in deep and the weight to only 30 lb. This is a considerable achievement for a set with a 9-in tube (picture 7½ in by 6 in).

The major difficulties in design with an H.T. supply of the order of 200 V only obviously lie in the line-scan circuits. The circuit is a more-or-less conventional blocking

oscillator feeding a pentode valve which in turn feeds the deflector coils through a transformer. A 'damping diode' is connected across the secondary and results in a considerable increase of efficiency. The primary is arranged as a step-up auto-transformer to increase the magnitude of the high-voltage pulse on fly-back. This is fed through a half-wave valve rectifier for E.H.T., the filament of the rectifier being fed from a winding on the line-scan transformer. As the current in this transformer must be kept constant if the filament of this valve is to be kept operating under proper conditions, the usual picture-width control by valve input is impracticable. A variable inductance in series with the deflector coil is used instead.

A permanent magnet is used for focusing. It has an adjustable shunt, but as there is no temperature drift, focus is no longer a panel control. It also needs no current. The frame scan is produced by a blocking oscillator feeding a pentode which is transformer coupled to the deflector coils. Sync separation is effected by a pentode and two diodes.

The receiver portion comprises a straight vision channel with four R.F. stages, diode detector and one V.F. stage. A second diode across the V.F. input acts as a noise limiter. The sound signal is picked out of the cathode of the third R.F. stage and after amplification in two further stages is fed to a diode detector and thence through a diode noise limiter to the pentode output valve. A.G.C. is provided on the sound channel, delay being obtained with the aid of a metal rectifier.

The H.T. circuit comprises a half-wave rectifier with a 50-μF reservoir capacitor and smoothing is effected by a single choke followed by a 100-μF capacitor. The valve heaters are series connected, including the C.R. tube heater; a tapped resistor is included for adjustments between 230 and 250 V and there is also a Thermistor in circuit as a regulator.

The set has 19 valves and the tube and costs 38 gns, plus purchase tax. The panel controls are sound volume, on-off and picture brightness only. The usual pre-set controls for line and frame hold, contrast and noise limiter among others are accessible at the rear of the cabinet.

World of Wireless (contd. from previous page)

Further particulars are available from the Board of Trade, Export Promotion Dept., Thames House North, Millbank, London, S.W.1. (Ref. E.P.D. 35814/48.)

Trade Literature relating to broadcasting equipment is wanted by the Chief Engineer, Dept. of Posts and Telegraphs, P.O. Box 1280, Salisbury, S. Rhodesia.

Pakistan.—Catalogues and illustrated trade literature are required for an information room to be opened at the office of the Customs Collector, Chittagong. They should be addressed to the Customs Collector, Information Room, Custom House, Chittagong.

India.—P.A. equipment is required by the Eastern Electric and Engineering Co., 127, Mahatma Gandhi Road, Fort, Post Box 459, Bombay, 1. Amplifiers of from 12 to 60 watts output for operation from 230-V, 50-60 c/s mains and, in the case of the lower outputs, from 6- to 12-volt batteries, are needed. Communications should be sent by air mail direct to the company. (E.P.D. Ref. 38434/48.)

G.E.C.—A multi-point low-level sound reproducing system has been installed by the General Electric Company in the Council Chamber of the Federation of Malaya. Thirty loudspeakers and thirty ribbon microphones distributed among the tables bring all members within range of a microphone

when they rise to speak. A single 60-watt amplifier provides the sound reinforcement, which is uniform in all parts of the chamber.

Twin-diversity equipment has been ordered from Marconi's for the Police Force of Eire. The main transmitters will be installed some three miles from the H.Q. in Dublin, from which they will be remotely controlled. The complete installation includes eight other headquarters sets, fifteen mobile equipments and fourteen receivers.

Twin-programme A.F. rediffusion equipment has been installed by the G.E.C. at Accra, Gold Coast, in place of the company's single-channel gear which has been in operation for some time. The equipment consists of four standard G.E.C. 500-watt amplifiers, four communication type receivers, gramophone gear and an O.B. unit. When the line extensions have been completed the will provide for some 5,000 subscribers.

East Africa.—Forty-eight Marconi short-wave transmitters are to be installed in Kenya, Uganda and Tanganyika, to provide ground-to-air and point-to-point communications for civil aviation services. Two types, the TGS541—a 200-watt set operating in the 1.5-23 Mc/s band—and the TGS501—a 100-watt set covering 1.5-13 Mc/s—will be used. A feature of the sets is the ease with which any one of six working frequencies can be selected.

Frequency Modulation

Some Comparisons with A.M.

MOST of the subjects I have discussed lately have been more or less related to modulation—amplitude modulation, to be precise. But nowadays frequency modulation is supposed to be “the thing,” so I need not apologize for returning to it.

There are already several large books devoted exclusively to F.M., so the next page or two cannot be expected to provide a complete education in the subject, but perhaps (shall we say?) a basis for intelligent interest.

The difference between amplitude modulation and frequency modulation is just what the names say—in A.M. the “information” (speech, music, code, etc.) is conveyed by varying the amplitude of a carrier wave; in F.M. it is conveyed by varying the frequency. If you had a transmitter you could A.M. it (at a rather low frequency!) by turn-

By “CATHODE RAY”

in series with the H.T. supply, this choke forming the output coupling of a M.F. power amplifier.

There are various ways of frequency-modulating, some of which are rather complicated. Many use a reactance valve—a valve in which the oscillatory voltage is applied to the input 90° out of phase, so that the output current (which is also in the oscillatory circuit) leads or lags, just as it does in an inductive or capacitive reactance. The amount of this synthetic reactance, and hence the frequency of the oscillator, is controlled by varying the slope of the valve at modulation frequency by means of the M.F. amplifier.

In A.M. the intensity or volume of the signal or programme being carried is repre-

zero. The depth of modulation is 100 per cent.

In F.M. the intensity is represented by the amount of variation in frequency of the radiated wave, called the *deviation*; and to modulate 100 per cent one would have to make the frequency fluctuate between zero and twice the unmodulated carrier frequency. That, needless to say, would be quite absurd. In practice, the maximum depth of modulation in this sense is generally not more than 0.1 per cent, and is often much less. A standard deviation for broadcasting is ± 75 kc/s, and the carrier frequency is usually over 75 Mc/s. For communications, ± 15 kc/s or less is commonly used.

This brings us to the important matter of bandwidth. In A.M. the bandwidth is twice the highest modulation frequency. In F.M. it seems obvious that the bandwidth is twice the deviation.

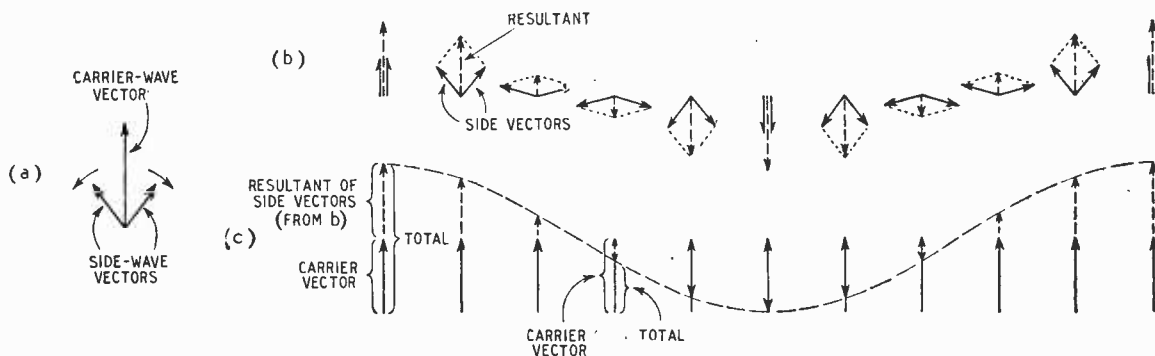

Fig. 1. A carrier wave and the pair of side waves caused by amplitude modulation at a single frequency are represented by the 3-vector diagram (a). The two side vectors alone are shown at successive stages during one modulation cycle at (b); their resultant (dotted vector) is always in line with the carrier vector, so can be directly added or subtracted from it, as at (c), which shows that the net effect of the sidebands is to vary the amplitude of the carrier wave at modulation frequency.

ing the anode voltage control up and down. Or you could F.M. it by turning the oscillator tuning control to and fro.

In practical A.M. the anode voltage is turned alternately up and down at any desired modulation frequencies by means of the voltage developed across a choke

represented by the amount of variation in *amplitude* of the radiated wave, and reaches a limit when the variation is equal to the unmodulated amplitude of the carrier wave, because then the carrier fluctuates between twice its unmodulated amplitude and zero, and it cannot go less than

Working on that assumption, inventors have from time to time hit on the bright idea of making the deviation very small, with the praiseworthy object of occupying a much narrower channel than would be possible with A.M. Alas for their young hopes, their assumption is wrong!

Frequency Modulation—

It certainly does sound reasonable to argue that if the frequency of the carrier wave is varied by, say, only ± 100 c/s, a 200-c/s band is all that is required for speech, music . . . television, even. But in disconcerting fact, the bandwidth is at least as great as with A.M., and in general is greater.

This seems an even more difficult statement to swallow than the one about amplitude modulation creating sidebands; and it is certainly more difficult to prove mathematically. But I hope that during the last few months (especially in "Sidebands Again," December, 1947), I was able to convince any doubters that A.M. does generate sidebands. The clearest way of visualizing them, I think, is with the help of a vector diagram. If you will agree that the A.M. vector diagram gives a correct analysis of A.M., I think I can undertake to show how F.M. spreads its sidebands to an equal or greater extent.

on to the carrier-wave vector which is rotating at carrier frequency, and move with it, so that relative to us it is stationary, and the two sideband vectors required for any one modulation frequency

the remaining one on its own will continue to vary the amplitude of the carrier. In fact, if its length is doubled, to be the same as the carrier's, as in Fig. 2(a) (instead of the half-carrier-length that is

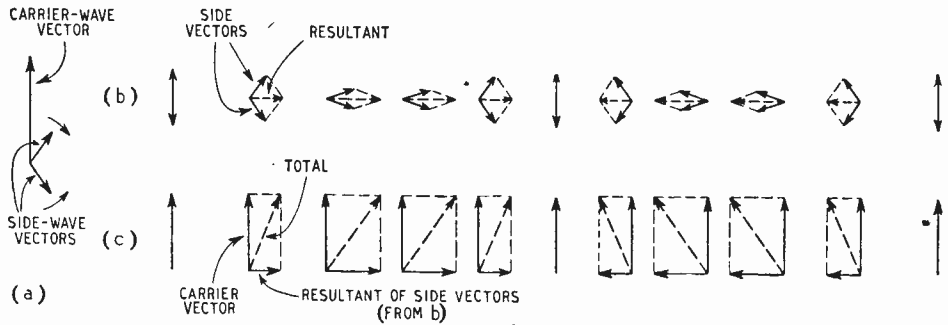

Fig. 3. Restoring the twin side vectors of Fig. 1, but reversing one of them, as at (a), makes their resultant always at right angles to the carrier, as shown stage by stage at (b). (Compare with Fig. 1.). Adding this resultant to the carrier (c) yields approximately pure F.M., provided that the "angle of wag" is kept small.

appear to be rotating comparatively slowly (at modulation frequency) in opposite directions. Their resultant, as we have seen so many times recently, and can see again in Fig. 1 (b), is always directly for or against the carrier vector; so as they rotate they alternately lengthen and shorten the carrier vector, Fig. 1 (c), thereby giving a correct representation of varying carrier amplitude.

the limit when there are two sidebands) the amplitude modulation is 100 per cent. But there are two complications. One is that the resultant of the carrier and single side-wave gives a distorted modulation. For example, when the side-vectors in Fig. 1 are at right-angles to the carrier vector they cancel one another out and the carrier is for an instant at its unmodulated amplitude; whereas with a full-length single-side

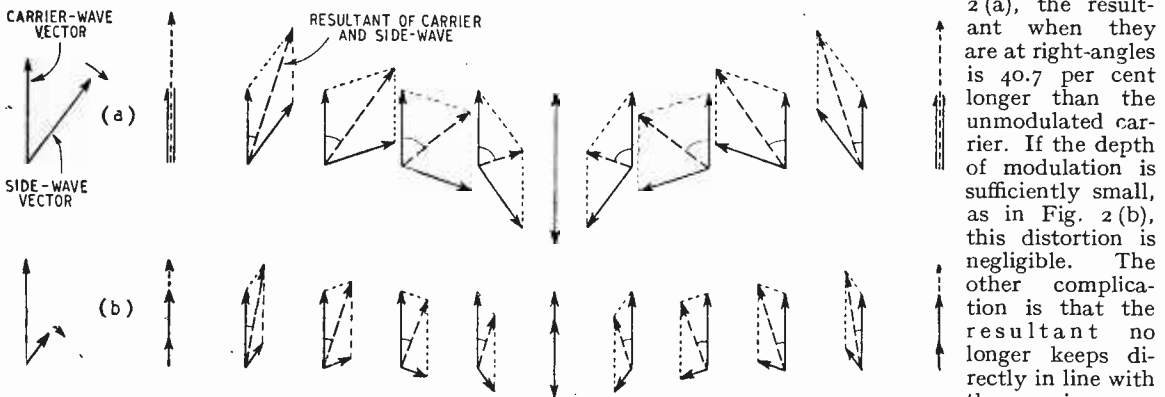

Fig. 2. If one side vector in Fig. 1 is omitted, and the other doubled (a) the amplitude modulation is distorted and becomes mixed with frequency modulation (indicated by the resultant of carrier and side vector wagging from side to side). Reducing the depth of modulation reduces the distortion (b).

Going back to the A.M. vector diagram, Fig. 1(a), you may remember that the trick is to climb

It is worth noting that if one side vector is abolished (to represent single-sideband transmission)

form speed, representing a constant frequency, the radiated wave alternately speeds up and

slows down at the modulation frequency. In other words, frequency modulation!

So we see that while three constant-frequency waves, as in Fig. 1, add up to give A.M., a combination of two waves, as in Fig. 2 (which can be called either single-sideband transmission or heterodyning, according to circumstances) yields a mixture of A.M. and F.M., both somewhat distorted.

Pure undistorted F.M. would be represented by a vector that maintained a constant length and waggled to and fro about its unmodulated position in time with the modulation. Can we find out what side waves must be added to the carrier wave to give this result?

We can, perhaps, if we are mathematicians of such a high order as would be ashamed to be seen reading "Cathode Ray." If we are not, we can quite easily build up a simple approximation which will at least explode the narrow-waveband fallacy.

The clue is in Fig. 2. Here a single side-wave produces F.M., but unluckily it is mixed with a lot of A.M. We have seen that a second side wave such that the vector resultant of the two is always in line with the carrier vector (as in Fig. 1) stops the F.M. wag and gives pure A.M. What we want is to keep the wag and stop the variation in carrier amplitude. Putting it like this, it is easy to see that a good step in the right direction can be achieved simply by rearranging the two side vectors so that their resultant is always at right-angles to the carrier vector instead of being in line with it. The combination with the carrier, as Fig. 3 shows, is a vector that wags in time with the side vectors, and keeps a tolerably constant length provided that the side vectors are very much shorter than the carrier vector. From this we conclude that A.M. can be converted into a nearly pure F.M. merely by shifting the phase of the sidebands by 90° (or, what comes to the same thing, reversing one of them), provided that the depth of modulation is small, as it necessarily is with F.M.

The important point to notice is that in order to make the carrier wave frequency vary at

modulation frequency, it is necessary to add side waves whose frequencies are the same as in A.M. For example, to vary a 1,000-kc/s carrier wave between 999.9kc/s and 1,000.1kc/s 2,000 times a second (i.e., at 2kc/s) it is necessary to generate frequencies, not of 999.9 and 1,000.1kc/s, but 998.0 and 1,002.0kc/s, making the bandwidth actually 20 times the deviation.

That may seem very surprising—almost incredible—but so at one time seemed the statement that varying the *amplitude* of a carrier wave necessarily brings into existence waves of different *frequency*. In both cases the vector diagram is the clearest way of visualizing the process.

For example, Fig. 3 has made it clear that if the "wag" is very small, the combination of a carrier wave and a pair of sidebands (just as in A.M. except for the 90° phase shift) is practically perfect F.M.; but if the wag were large the simple pair of side frequencies for each modulation frequency would not be enough to make pure F.M.; there would have to be other vectors to neutralize the progressive lengthening of the combined vector towards the extremes of its wag. So one would (quite rightly) expect the sidebands to be more complicated than with A.M. The important quantity, evidently, is what might be called the "angle of wag." Comparing Fig. 3 with Fig. 1, it seems to be the F.M. equivalent of depth of modulation; a more sensible one, anyway, than our previous idea of depth of frequency modulation as deviation.

To understand carrier frequency clearly what this important "angle of wag" in the vector diagram corresponds to in real life may demand rather close attention.

Obviously, the size of the angle depends on the lengths of the side vectors relative to the length of the carrier vector. Yes, but what decides the lengths of the side vectors? In A.M. it is easy—the amount by which the carrier amplitude increases and decreases as a result of modulation. In F.M. it presumably has something to do with the deviation.

Suppose you have a clock that always keeps perfect time, and

And now the STANDARD RACK

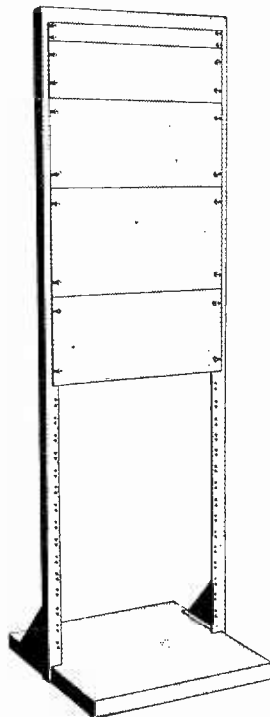

Latest edition to the Imhof range of cases is the new Standard Rack and Panel assembly. Of heavy gauge mild steel angle, it is strongly constructed with welded corners, and finished in grey stove enamel. Standard 19" Rack panels of 1/8" thick mild steel plate are available in four sizes:—13", 5 1/2", 8 1/2" and 10 1/2" deep finished in grey stove enamel.

Prices:—
 Standard Rack frame 5' 6" high £4 15s. 0d. each
 Panels 19" x 10 1/2" 11s. 3d. ,,
 " 19" x 8 1/2" 8s. 9d. ,,
 " 19" x 5 1/2" 5s. 7d. ,,
 " 19" x 1 1/2" 3s. 2d. ,,
 Plated chassis with associated mounting brackets 15s. per set



PRECISION BUILT INSTRUMENT CASES
 112-116, NEW OXFORD STREET,
 LONDON, W.C.1
 Telephone: MUSEum 5944

Frequency Modulation—

also an electric clock driven from the public supply. Suppose that the hour hand of the perfect clock is removed, and the minute hand of the electric clock coupled up in its place. Then if the supply mains were always exactly on frequency the minute hands of the two clocks would always be exactly superimposed and move as one hand. Except for the unconventional direction of rotation, they could be regarded as a vector representing an unmodulated carrier wave, working at the admittedly rather low frequency of $\frac{1}{3,600}$ c/s. By turning the clocks themselves steadily round anti-clockwise once per hour, the minute hands would be made stationary, pointing (say) upwards, just as we "froze" the carrier vectors in Figs. 1-3.

Now suppose that there is a cold day, causing the daytime load to exceed the capabilities of the plant, so the Electricity Board adopts (as it usually does) the expedient of reducing the frequency. ("Free Grid" has imputed to the Government the baser motive of lengthening the working day in order to get more output, but I won't discuss that.) The electric clock consequently loses, so that gradually its minute hand diverges to the left. By the end of the power-load day it has reached its maximum divergence (or "angle of wag"). During the night the E.B. speeds up the generator, bringing the frequency above normal; and if they have managed it cleverly the two hands again coincide next morning. To make the analogy perfect, the E.B. would have to forget to slow the machines down during the second day, so that the electric clock would continue to gain, making its minute hand diverge to the right. The cycle would be completed during the second night if the E.B. discovered their mistake and reduced frequency.

The modulation frequency in this case is clearly 1 cycle per 2 days. (The carrier frequency, in the same units, is 48 cycles per 2 days, because that is the rate at which the minute hand of the perfect clock goes round relative to the clock.) What decides the angle of wag? Obviously two

things—the rate of decrease and increase in the minute-hand frequency of the electric clock, and the modulation frequency. If the E.B. kept up their go-slow policy for a week on end, the divergence between the two minute hands would clearly be 14 times as great as for the 12-hour period imagined above. So in F.M. the angle of wag is inversely proportional to the modulation frequency. Its relationship to the rate of losing and gaining is slightly complicated by the question of how the rate occurs. The easiest case to consider would be the one in which the slowing was applied suddenly and maintained at a constant rate all day, followed by a sudden speeding up maintained steadily all night. Suppose the deviation were half the modulation frequency, that is to say, 1 cycle per 4 days. Then in 12 hours (one quarter of a M.F. cycle) the divergence would amount to one-eighth of a revolution of the minute hand, or 45°.

This would be too large an angle of wag to be represented with reasonable accuracy by Fig. 3 (one pair of M.F. vectors). Either the frequency deviation would have to be reduced, or the period of the modulation cycle reduced (M.F. increased).

The above method of applying the frequency modulation is what we would call modulating by a square wave. The angle of divergence increases steadily throughout one quarter of a modulation cycle, so the lower the M.F. the greater the angle of wag. A little consideration of the above example

shows it to be $360 \times \frac{f_d}{4f_m} = 90 \frac{f_d}{f_m}$ degrees, where f_d is the frequency deviation and f_m the modulation frequency.

In radio one is generally more interested in sine-wave modulation, in which the frequency is varied gradually, and the full frequency deviation occurs only at the peaks of modulation. Obviously the angle of wag will be less than for square wave modulation, because the average rate of losing and gaining is less than the peak rate. It is a simple problem in integral calculus to show that the average value over each half-cycle of a sine wave is $\frac{2}{\pi}$ times the peak value. So with this sort of

modulation the angle of wag (call it θ) is

$$90 \frac{f_d}{f_m} \times \frac{2}{\pi} = \frac{180}{\pi} \frac{f_d}{f_m} \text{ degrees.}$$

Expressing θ in radians instead of degrees we have the simple formula

$$\theta = \frac{f_d}{f_m}$$

So our angle of wag in radians with sinusoidal modulating wave-

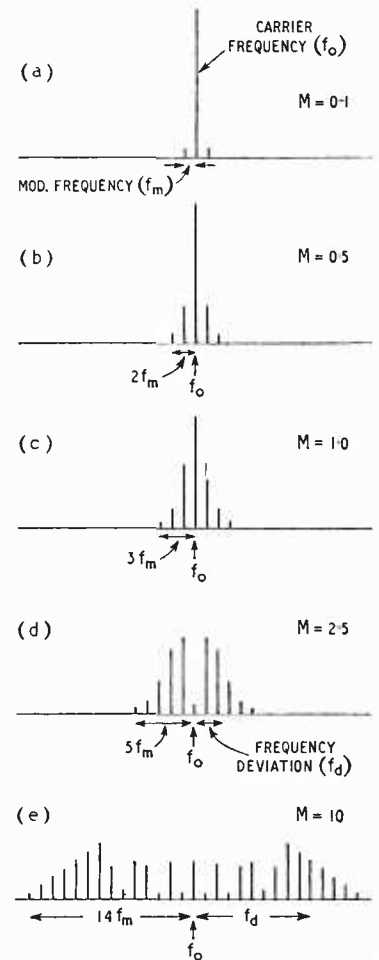

Fig. 4. When the "angle of wag" or modulation index, M, is small, the only appreciable sideband frequencies in F.M. are the same as those for A.M. (a). As M is increased, more side frequencies are generated, so that the bandwidth needed is always more than double either the modulation frequency or the frequency deviation.

form is equal to the ratio of frequency deviation to modulation frequency.

This ratio, which is the most

useful way of reckoning depth of frequency modulation, is usually called the *modulation index* and denoted by M .

When M is much less than 1, as in Fig. 3, the modulated wave is very nearly the same as if it consisted of a carrier and two side waves, as shown by Fig. 4 (a) for a single f_m . When it is increased, the first thing that is necessary to add to the simple vector diagram is something that will subtract from the length of the resultant vector at the extremes of its wag; that is to say, twice during every modulation cycle. That again is only an approximation; for greater accuracy, frequencies spaced 3, 4, 5 etc., times as far from the carrier are needed. It is difficult to calculate their amplitudes, but they can be derived from Bessel functions. If you understood Bessel functions you would hardly be reading this; but fortunately it is not necessary to understand them, because most radio engineering books, and certainly all books on F.M., give tables or curves of Bessel functions from which the amplitudes can be read off. Fig. 4(b-e) shows how they build up as M is raised. Notice how, unlike A.M., the carrier amplitude varies and may even disappear.

The thing to remember is a rough rule that the total bandwidth needed in an F.M. system is equal to $2(f_m + f_d)$ (compared with $2f_m$ in A.M.). Amplitudes outside those limits are so small that loss of them causes negligible distortion.

Seeing that the last thing one generally wants is to spread the bandwidth of a transmission wider than necessary for the modulation frequency to be carried, why use large deviations? Why (since, with the smallest f_d , $2(f_m + f_d)$ must be greater than $2f_m$) use F.M. at all?

That is too long a story to start at this stage, and has been pretty fully argued in the technical press. But briefly—

The F.M. transmitter does not have to handle 100 per cent. increases in carrier amplitude as in A.M., so can be smaller. The modulator can also be much smaller than is generally needed for high-quality A.M. It has often been said that better quality can be obtained from F.M., but there

is no foundation for that, except in so far as reduced liability to noise may be said to give an improvement in quality.

It is this noise reduction that is the main argument for F.M., and very shaky argument some of it often is. There are two main sorts of noise; the general rushing sound (fluctuation noise) that is inevitable whenever a signal is so weak that amplification has to be pushed to the limit, and the clicks due to motor ignition and the like. In any reception that is worth while, the amplitude of the first sort of noise is much less than that of the signal; and in this case F.M. gives a better signal-to-noise ratio than A.M., especially if M is made large, and pre-emphasis is used (see "Cathode Ray" for May, 1947). A large M means a large bandwidth, for which there is no room except at very high carrier frequencies. On such frequencies the usual sources of non-fluctuation noise generally cause little disturbance, with the important exception of ignition. This consists of brief pulses usually many times greater in amplitude than the signal. So naturally they sound like machine guns in the ordinary A.M. receiver, especially as its high selectivity prolongs the duration of each pulse. The F.M. receiver, with a constant-amplitude signal to work on, is fitted with a limiter which cuts all the peaks down to signal level, and its wide bandwidth preserves their brevity. What F.M. enthusiasts usually ignore in their comparisons is that A.M. receivers, too, can be given wide bandwidths, and de-emphasis, and limiters that follow the modulation. When the comparison is fair there is little difference between A.M. and F.M. in regard to impulsive noise, or to fluctuation noise that is either negligible or comparable with the signal. At receiver sites where fluctuation noise is appreciable (for example, beyond the range of quiet A.M. reception), F.M. is beneficial. But only so long as the receiver is accurately tuned.

There are many other things to take account of in a comparison, and I have only hinted at F.M. receiver technique; but being limited for space I have picked out the points that seem to cause most confusion. I leave the rest to the copious literature of F.M.

ACE RADIO

MODEL 600

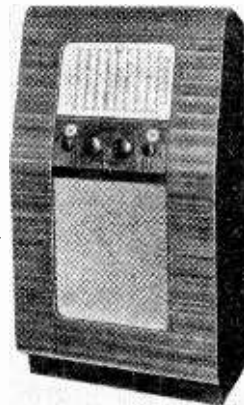

DESIGNED FOR THE DISCRIMINATING LISTENER

'Ace' Model 600 Console Receiver gives world-wide coverage and ease of tuning on short waves, combined with high quality reproduction. Fitted with a 7 valve chassis (plus magic eye and rectifier).

The receiver with its R.F. stage operating on all short wave bands and full electrical bandspread has an excellent performance with a high order of stability and complete absence of microphonic feedback even at the full audio output of its generous push pull output stage. The tone system, in addition to varying the audio response, broadens the selectivity characteristic of the I.F. amplifier to permit reception of the higher modulation frequencies.

PRICE £45

Plus £9.12.6 Purchase Tax

Full Technical Specification
gladly supplied

ACE RADIO Ltd.

TOWER RD., WILLESDEN,
LONDON, N.W.10.

'Phone :
Willesden 3904-5

Unbiased

By FREE GRID

λ and \sim

IT seems a great pity that we cannot get rid of wavelengths altogether and concentrate on frequencies but if we must retain, for the sake of the weaker brethren, the easily visualized idea of curves, let us at least make the conversion of frequencies to wavelengths and vice versa an easy and straightforward see-at-a-glance business. It certainly is not very easy at present owing to the awkwardness of the factor 3.



Justifying her household accounts.

The Moguls of Broadcasting House, who ought to know better, still put the frequency half apologetically in brackets following the wavelength in the *Radio Times*. Judging by the dial calibrations of their products, most set manufacturers don't seem to have heard of frequencies, and it is very irritating to have to convert 216.8 metres to 1384 kc/s when tuning in.

It has always been a matter of great difficulty to get the public to abandon or correct obsolete and obsolescent methods of measuring time and space. One of my ancestors, writing in September, 1752, complained bitterly about the trouble which the government of the day was having to convince the unlettered masses that the Julian system of celestial chronometry had become sadly out of step with actuality.

If, therefore, we must continue to dabble in wavelengths let us at least make their relationship to frequency an easily calculable one. This we could very well do by abandoning

the metre and returning to the foot as the unit of λ measurement. Those of you who, like myself, have been associated with wireless since the 'nineties will hardly need reminding that in those stirring days λ was invariably expressed in feet. If my memory serves me right, sets used in the Boer War were so calibrated.

The advantage of returning to feet is obvious since 1 Mc/s = 1,000 ft, 10 Mc/s = 100 ft and so on. Admittedly the relationship between Mc/s and feet is not quite as exact as I have made it out to be, but by a little permissible jugglery, of far less magnitude than that which a woman uses to justify her house-keeping accounts or a politician his statistics, this can be rectified. All that is necessary is to adopt a "New Look" foot which instead of being equivalent to 30.48 cm, has a value of 29.9793 cm. This latter value is based on the latest measurement of the velocity of propagation by means of the cavity resonator method which, according to the N.P.L., is 299,793 \pm 9 km/sec.

This new "foot" linked as it would be to something unalterable like radio propagation might well be used as the basis of a new British Decimal "Metric" system, the advantage of which would readily be seen and eagerly adopted by the whole world. It would thus be up to the President of the Board of Trade to seize the opportunity of redressing our trade balance by arranging for the manufacture and export of countless millions of the "New-foot" rules and in his honour I think we might well call the new unit the "Barefoot."

The Cosmetometer

PEOPLE have often asked me who can legitimately be termed the inventor of what has come to be called radar. I suppose that the correct answer is Prometheus, for, prior to his daring fifth column activities in the celestial spheres, man did not possess any means of generating electro-magnetic waves. It is fairly safe to say that after using his new possession to cook his morning kipper Mr. Everyman was

quick to notice that he was able to come into the house after nightfall without tripping over the mat, thereby laying himself open to a barrage of questions from his better half about the way he had been spending his evening. This undoubtedly constituted true radar since Mr. Everyman's ability to see the mat was due to U.S.W. generated by himself and not by the moon.

Prometheus could not, however, have foreseen the manner in which the fruits of his kleptopyretic activities were to be used countless centuries hence by Watson Watt and others any more than Watson Watt could have foreseen to what base ends his pioneer work of the middle thirties would be put in 1948. I myself would scarcely have credited it had I not had the good fortune to pick up a bundle of typewritten papers in a taxi. They had apparently been left there with all the careless abandon with which people seem to leave their pheno-barbitone tablets lying about. The fact that the papers were tucked into a heavily thumbled copy of *Wireless World* led me to glance at them. I was astonished to find a complete specification of an invention prepared for submitting to the Patent Office in the joint names of a very well-known radio engineer and an equally famous women's beauty specialist.

The basic idea of this so-called cosmetometer was that the radar echo from the actual skin on the face of the female being "made-up" in a beauty parlour would arrive back a split micro-second later than the echo from the surface of the make-up paint, the time difference between the two being used to indicate the thickness of the make-up on her face and lips. Apparently it is of the utmost importance that some women should have a greater thickness of "coverage" than others. Speaking as a family man used to sitting round a breakfast table with a varied collection of women in the raw, I can very well believe that, and the inventors have my heartiest good wishes for the success of the idea.



Women in the raw.

LETTERS TO THE EDITOR

Reducing Televisor Noise + Shortcomings of Direct Coupling + Functional Circuit Diagrams + Radio Jargon

Long-range Television

I AM interested in H. W. N. Long's letter (your June issue) and the limitation in television reception due to noise which he has experienced.

I have not for some years experienced television reception on very low field strengths but I would suggest that, if the noise he refers to is receiver noise and not local interference, the "Cascode*" circuit might be of interest as a possible means of improvement.

The circuit consists of two triodes, the first grounded-cathode, the second grounded-grid, and the gain is about the same as that of one pentode of comparable slope. Design and adjustment do not appear to be particularly critical and for 6 Mc/s bandwidth at 45 Mc/s the noise factor should be about 1.75db.

H. G. M. SPRATT.

Enfield, Middx.

*Proc. I.R.E., June, 1948, p. 700;
Wireless World, July, 1948, p. 249.

Direct-coupled Amplifiers

THERE has been a noticeable trend during the last year or so to regard direct coupling (your July issue, p. 266) as the apogee of refinement in audio-frequency amplifiers, conferring untold (and usually unspecified) benefits on the ultimate performance. Since this form of coupling normally involves sacrifices in other directions it is worth while examining the basis of the claims somewhat critically.

The following are the chief advantages adduced by the advocates of directly coupled amplifiers:—

- (i) the gain/frequency response can be effectively maintained to a very low frequency;
- (ii) the phase shift at low frequencies can be reduced to a low value;
- (iii) the small phase shift at low frequencies permits the application of a large amount of negative feedback;
- (iv) the small phase-shift produces a corresponding improvement in transient response.

Let us examine these claims individually and collectively.

With a normal type of resistance-capacitance coupling using typical values, say a 0.02- μ F condenser and

470-k Ω resistor, the drop in response at 30 c/s is only 1db, while if 0.1 μ F and 470-k Ω are used the drop is only 0.05db. The corresponding phase shifts are 28° and 6°. In other words, the fall in response and phase shift, even with the smaller value of coupling, are completely negligible at the lowest frequencies in the audible range.

The next argument presupposes that when negative feed-back is applied the stability limit is set by the phase rotation at low frequencies. It is rare in practice that this is the case; when a large amount of degeneration is attempted oscillation invariably occurs first in the upper frequency range, if the feedback loop includes the output transformer.

This high-frequency instability is, in turn, largely determined by the gain and phase characteristics at the higher frequencies. Now if direct coupling is used we are immediately circumscribed in our choice of coupling methods, since the satisfying of the D.C. conditions must be our prime consideration. As a result normal directly coupled amplifiers tend to be of low gain and consequently, for a given total gain, a large number of stages is required.

It is easy to show that the permissible degree of negative feedback is determined by the number of stages (see Dr. Buss' equation given in Terman's "Radio Engineering Handbook"); this evolves from the fact that, at high frequencies, each stage is, effectively, a resistance and capacitance in parallel.

It is therefore true to say, in general, that a greater degree of feedback can be applied to an amplifier consisting of a small number of high-gain stages than one with a large number of low-gain stages, even where these are directly coupled.

Finally, the transient response of the system will be determined, largely, by the high-frequency gain and phase characteristics; it has just been shown that, owing to the concomitant circuitry limitations imposed by direct coupling, the transient response may, in fact, be rather poorer than with normal conditions.

The disadvantages of direct coupling, difficulties in initial setting, variation of conditions with ageing valves and dependence on the sta-

New TRIX Quality SOUND EQUIPMENT

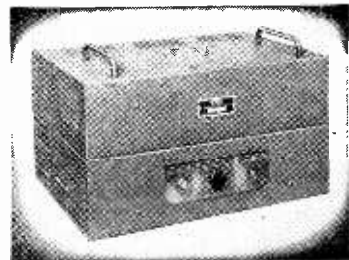

60 WATT Amplifier . . . T663 B.

This amplifier provides the full rated power by the use of four valves in a parallel push-pull output circuit with inverse feedback. It is a high gain 4-stage amplifier which can be used singly or in combination with supplementary units Type T663/S to provide power outputs of 120, 180, 240 watts, or higher. Where a number of separate inputs are required, our 4-way or 6-way Electronic Mixer can be connected. Like all Trix Amplifiers, the T663B is designed for adaptation to rack mounting.



TRIX RIBBON MICROPHONE

is designed for high quality reproduction. Frequency response substantially linear from 60-10,000 c.p.s. Minimum feedback. Send for full details.

THE TRIX ELECTRICAL CO. LTD.
1-5 Maple Place, Tottenham Court Road,
London, W.1. Phone: MUSeum 5817;
Grams & Cables: "Trivadio, Wesdo, London."

AMPLIFIERS · MICROPHONES · LOUDSPEAKERS

Letters to the Editor

bility of HT. supply, are, of course, too well known to require elaboration.

The writer has noted that the devotees of direct coupling are not above using RC networks for equalization of recording characteristics, tone controls, or decoupling of screen and cathode circuits, any of which may produce its own phase shift. There are, of course, certain specialized requirements where direct coupling is essential; e.g., in video amplifiers and electronic control equipment: for normal audio-frequency use, however, it is not worth while sacrificing the freedom of action which normal coupling affords for the illusory advantages of direct coupling.

E. JEFFERY.

Arborfield, Berks.

"Quality in the Home"

TO say, as you do, Sir, that you are not entirely convinced by all the arguments adduced by H. S. Casey in your August issue is, I should imagine, an example of the masterly understatement for which we British are famous.

So many fallacies gathered together in one place should provide fair shares for all readers in the sound-quality section to discuss, so I will confine my comments to the account of my alleged activities in 1938, which is a complete misrepresentation. In the article referred to by Mr. Casey (March 10th, 1938), so far from advocating scale-distortion remedies, such as a weighting

network, as a result of the great difference between actual and reproduced levels of sound disclosed by tests in the Queen's Hall, I showed that under the quite typical conditions described there was no substantial difference. And where, for various reasons, sound reproduced in the home has to be at a much lower or higher level than the original, I have insisted from the start (Sept. 24th, 1937) that the remedies commonly proposed—"bass compensation," etc.—are usually fallacious and may sometimes even make matters worse.

Mr. Casey has confirmed my impression that after all these years the "Cathode Ray" picture of this subject has faded or become defocused in many minds, or perhaps was insufficiently clear in the first place, and ought to be rescanned. This, if you were to agree, and to reserve the necessary area of screen in a future issue, I would be very ready to do.

"CATHODE RAY."

Directional Arrows

IN your April issue, I dealt with directional arrows in a frivolous manner; here is a serious suggestion.

In your July issue a circuit diagram on page 266 contains a two-way switch for feeding the grid of a valve from "Radio" or "Pick-up." The switch is shown as at (a) in my diagram.

Since the direction of cause-to-effect is from the pick-up to the valve, I suggest that the circuit

would have been better drawn as at (b).

This way of drawing the arrows corresponds to the verbal explanation

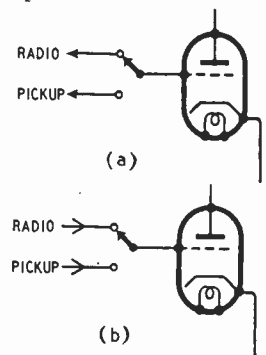

ation "The (output of the) pick-up is fed to the grid."

L. H. BAINBRIDGE-BELL.
Haslemere, Surrey.

Superlatives

AS technical librarian in an engineering organization I should like to endorse heartily all you say about the use of superlatives in your July editorial of *Wireless World*. I think, however, that the situation is even worse than you have suggested. For instance, the words "super" and "ultra," have come to indicate even a difference in kind—"supersonic" embracing velocities higher than sound, and "ultrasonics" frequencies above the audible range.

This would be all very well if it was adhered to strictly, but we find at least one manufacturer marketing apparatus labelled "supersonic" when it uses high frequency, not high speed, sound waves.

The professional institutions or the standards institutions should make some effort in this matter quickly or technicians and librarians alike will be lost in ultra confusion!

A. L. VINYCOMB.

Clacton-on-Sea.

"Meaningless Misnomers"

"FREE GRID" has taken me to task for suggesting, in *Wireless Engineer*, that certain prefixes should be used. In part, his objection is that I have seen these prefixes in print. I can only confess meekly that it was the best print: these prefixes are recommended by the International Standards Authority (I.S.A.), and as the *W.E.* correspondence was about standardization, it seemed to be no place for unconventional suggestions.

The real trouble is that the Greeks never needed to refer to 10^{12} or 10^{-12} . "Free Grid's" suggestions appear to me to be quite unsuitable: hexagon and sextet are



Books Published for "Wireless World"

	Net Price	By post
RADIO LABORATORY HANDBOOK. Fourth Edition, by M. G. Scroggie, B.Sc., M.I.E.E.	12/6	12/11
TELEVISION RECEIVER CONSTRUCTION. A reprint of 10 articles from "Wireless World"	2/6	2/9
FOUNDATIONS OF WIRELESS. Fourth revised Edition, by M. G. Scroggie, B.Sc., M.I.E.E.	7/6	7/10
WIRELESS DIRECTION FINDING. By R. Keen, M.B.E., B.Eng. (Hons.), Fourth Edition,	45/-	45/9
TELEVISION RECEIVING EQUIPMENT, by W. T. Cocking. M.I.E.E., Second Edition	12/6	12/11
WIRELESS SERVICING MANUAL, by W. T. Cocking, M.I.E.E., Seventh Edition... ..	10/6	10/10
HANDBOOK OF TECHNICAL INSTRUCTION FOR WIRELESS TELEGRAPHISTS, by H. M. Dowsett, M.I.E.E., F.Inst.P., and L. E. Q. Walker, A.R.C.S., Eighth Edition ...	30/-	30/8
BASIC MATHEMATICS FOR RADIO STUDENTS, by F. M. Colebrook, B.Sc., D.I.C., A.C.G.I.	10/6	10/10
GUIDE TO BROADCASTING STATIONS, Third Edition ...	1/-	1/1
RADIO DATA CHARTS, by R. T. Fea'ry, M.A., B.E., D.Sc., Fourth Edition—revised by J. McG.Sowerby, B.A., Grad.I.E.E.	7/6	7/11

Obtainable from all leading booksellers or from

ILIFFE & SONS LTD., Dorset House, Stamford Street, London, S.E.1.

already in the language with the implication of "x6" and I think it would take most of us a long time to learn whether "hex" was now to stand for 10^6 or 10^{-6} . His 10^3 and 10^{-3} cannot be abbreviated because they are both the same.

The proposed prefixes do not cause me that horror which they produce in "Free Grid." Already we have mega and micro, neither having any obvious connection with 10^6 or 10^{-6} . Nano, a dwarf, seems quite good for 10^{-9} , while "giga," the root of gigantic, should be easily remembered. Tera, which was got into the English language as the root of teratology, meant a miracle, or a portent. This is just the prefix for 10^{12} , and I never regarded Jack the Giant-killer as a cure for school-girl laughter.

There is, I think, no real reason for clinging to Greek in seeking a prefix for cycles per second. The essential thing is that we should have a short prefix which cannot cause confusion when abbreviated. Mega, milli and micro are a good group which should be broken up.

The whole question of word-creation requires great care. The text-books are littered with carefully invented words, like audion and rhumbatron, which have failed to stick. "Pf" and radar are examples of words which work: micro-microfarad and radiolocation are examples of words which do not.

Stockholm. H. JEFFERSON.

Tax on Valves

THIS tax on valves (although reduced) is still beyond a joke. If through unlucky accident a valve goes up in smoke a proportion of the cost involved goes up in purchase tax. We don't destroy our valves for fun! Our Chancellor should relax. It's hard to have to suffer from the output valve distortion because we simply can't afford this Government extortion.

Transformers and capacitors are both exempt from tax; why should valves be singled out? is a question we all ask. We listeners have almost reached the limit of our tether: we want this unfair tax on valves* abolished ALTOGETHER.

ROBERT C. BELL.

Ambleside.

*and H.T.B.s.

Feedback and Distortion

THE letter from Howard Booth in your June issue on the subject of overload distortion in amplifiers with negative feedback calls attention to the possibility of distortion being produced by frequencies outside the normal desired pass band or within the extended range of the amplifier due to f-b.

I would like to add some remarks covering the more general case of frequency selective f-b, whether introduced by a selective network as tone control or present as the result of deficiencies in the amplifier itself.

Where there is a level frequency input to the amplifier, any increase in gain of a range of frequencies, brought about by reduced negative f-b, at those frequencies, must result in overload unless the general output level is reduced. This effect is noticeable in amplifiers where bass boost has been obtained by selective f-b to compensate for deficiencies in the loudspeaker system, overloading occurring in the bass well before the amplifier is fully loaded at other frequencies. It can also take place where the amplifier itself introduces frequency distortion and where no deliberate selective f-b is employed, as a smaller degree of f-b automatically takes place for those frequencies which are subject to less amplification (without f-b), thus increasing the effective input. This could be tolerated if the lower normal gain were spread evenly over the various stages or possibly if it were confined to the first stage. Unfortunately such deficiencies are usually mostly encountered in the output stage and either this stage or an earlier one will be overloaded if considerable f-b is employed.

The above argument applies where there is a level frequency input. Where the input is deficient in a certain range of frequencies it is quite possible to use selective f-b to boost them to the general level, without distortion. Tone control in the form of attenuation by selective f-b is, of course, also quite harmless.

It will be seen, therefore, that if it is desired to straighten out the response curve of an imperfect amplifier by means of negative f-b a lower output level must be accepted if distortion is to be avoided. This may be somewhat offset by the larger apparent output in the bass. Treble boost by selective f-b is not likely to introduce trouble if careful attention is paid to phase shift in the network, but it is best, in my opinion, to confine the use of bass boost to cases where the input is lacking in the low notes, such as with the modern types of pickups, unless a lower general output level can be tolerated.

Newquay. C. C. GERRY.

Surgeless Volume Expansion—Correction

In this "Letter to the Editor" (our June issue) the double diode valve type should have been given as 2D4B. The cathode resistor of the "signal" AC/SP1 valve is 680 ohms.—EDITOR.

M. WILSON LTD

HIGH FIDELITY 12 WATTS AMPLIFIER

For Frequency modulation, television and gramophone reproduction. Separate treble and bass control. Blue Prints, 2 full size practical and theoretical 7/6.

T.R.F. QUALITY PUSH-PULL RECEIVER

For first-class radio reproduction on the 3 standard programmes, (Third, Light and Home) Blue Prints, 2 full size practical and theoretical 7/6.

DOUBLE SUPERHETERODYNE

An unusual circuit with an unusual lay-out. Range $2\frac{1}{2}$ to 2,000 metres, including frequency modulation, television sound, short waves and standard broadcast bands. Set of blue-prints for full size. Price 15/-.

CIRCUIT NO. 20

10 valves, six wavebands, R.F. stage, push-pull output, 12 watts, Superheterodyne receiver. Blue Prints 7/6.

6-VALVE SUPERHET CIRCUIT

3 wave-bands, A.C. only. A circuit that will please the most critical. Blue prints, 2 practical and 1 theoretical, with detailed price list of components 7/6.

4-VALVE BATTERY SUPERHETERODYNE 8B

3 wave-bands, low consumption valves. Blue prints, 2 full size practical and 1 theoretical, and detailed price list of components 7/6.

TELEVISION HOME CONSTRUCTORS' ELECTRO- STATIC DEFLECTION— CIRCUIT No. 1

Blue prints, 2 full size practical and 1 theoretical, and detailed price list of components 10/- per set.

SIX WAVE BAND COIL UNIT BOX TYPE

Wired up, tested and calibrated 5 to 2,000 metres, including Aerial H.F. and Oscillator £6.

VARIABLE SELECTIVITY I.F. TRANSFORMERS

465 kcs. giving the choice of three degrees of selectivity. 1. High Selectivity. 2. Medium. 3. High Fidelity. Controlled by three position switch. Iron cored, screened. The second I.F. is centre tapped on both primary and secondary to reduce damping. Circuit diagram supplied. Price £1 per pair.

307, HIGH HOLBORN.
LONDON W.C.1. Phone: HOLborn 4631

Random Radiations

By "DIALLIST"

Aircraft and Television

SEVERAL CURIOUS INSTANCES of interference into television reception by aircraft have been reported at intervals in *Wireless World*. What one may call the normal type is that due to the arrival of the signal direct and also by reflection from the aircraft. The effect of this is to produce a "ghost" image, the displacement of which from the original depends on the difference between the lengths of the two paths. Another phenomenon reported is the appearance of vertical light and dark stripes over the image. That, I believe, may be due to the reception of radar pulses reflected from the aircraft. In last month's issue R. M. Staunton-Lambert briefly described what seems to be a different form again. What he finds is that, though sync is more or less unaffected, the light density of the image fluctuates. This set me thinking of the effect we used to call "beating" which was often seen on G.L. Mark II radar receivers during the war. The "break" corresponding to a particular plane, after being quite steady for thousands of yards of the course flown, would start flopping up and down, rather like the flame of an oil lamp when the reservoir is just about empty. This often happened when the plane was making a turn. The explanation given by the pundits was that it was due to reflections from the revolving propeller at certain angles. The normal speed of propellers is, one was told, 1,500 r.p.m. In the G.L. Mark II receiver there is a rotary aerial switch driven by an induction motor from a 230V, 50-c/s supply. The switch therefore rotates at rather under 3,000 r.p.m. The beating was supposed to be caused by the arrival of the reflections varying 1,500 times a minute at an aerial system switched at 3,000 r.p.m. Now, in the television receiver there's also a form of switching at 3,000 times a minute—the frame time base, with its 50 scans a second. It seems possible that when the plane is in certain positions in relation to the receiving aerial,

varying reflections from its rotating propeller interact with the frame time base and cause beats in the form of fluctuations of light density. It would be interesting if the correspondent who made the report could compile some data on the position of the plane (i.e., flying straight or turning, head-on, tail-on or broadside-on) when the interference is at its maximum and minimum. I should mention, by the way, that there's another similarity between G.L. II and the television receiver in the frequencies used. Those for G.L. were also of metre order: 54–86 Mc/s, if I remember aright.

Ultrasonics

UNTIL THE OTHER DAY, when one whom I may term a front-room, rather than a back-room boy of the Department of Scientific and Industrial Research had lunch with me, I hadn't realized how much activity there was in this country at the present time in the way of research and development in ultrasonics. Ultrasonics is concerned with vibrations at frequencies between 20 kc/s and 2 Mc/s. Some super-enthusiasts see in it the answer to half the problems with which mankind is faced to-day. Others, taking a more realistic and sensible view, believe that in ultrasonics we have, if not a universal panacea, at all events something with great potentialities. So far, only two types of ultrasonics generators have been evolved, the magnetostriction and the piezo crystal. Each has its pros and its cons. The magnetostriction type can develop useful amounts of power; but it becomes very hot in operation and liquids to which it is applied boil. In the piezo-crystal generator the power is developed at the surface of the crystal. Crystals are fragile and delicate things and you might hardly associate their physical vibrations with kilowatts of power. Yet at least two British concerns have got far enough already with crystal generators to be talking in terms of at least half-kilowatts of mechanical energy. The practical applications? They're

legion. The lay papers have already given some account of the success in laundering operations (the dirt is literally shaken out of soiled clothes) obtained by the Mullard Electronics people, who are concentrating on magnetostriction generators—it's all to the good if the water does boil when you're using it for washing. Non-destructive tests of materials is another big field.

Wide Fields

IN THE OLD DAYS the only known way of obtaining an idea of the quality of castings, forgings, steel ingots and so on was to cut up a certain percentage of each batch in order to discover whether or not they contained flaws, air holes or "pipes." Then came the X-ray method, which has the great advantage (particularly in the case of expensive finished articles such as aeroplane propellers or gun barrels) that none of a batch is destroyed during the tests. Further, the destruction method is not a certain one; faults may be present in just those pieces which escape being tested. Ultrasonics already provides a means of making the tests previously carried out by X-rays. The generator is far less expensive and the results are most promising. In some of the tests radar methods are employed. Take the testing of a casting in the form of an armchair. Vibrations are applied at the circumference and are normally reflected back to a receiver, also at the circumference, from the boundary of the central hole. By means of a C.R.T. display the normal time for the out-and-home journey is measured. Should there be a flaw, reflection will take place from its boundary and the shorter travel time will be shown up by a displacement of the break on the timebase trace. Castings of irregular shapes may be tested in the same way, but as many reflections occur here, a skilled operator is needed to interpret them correctly.

Spelling Bee?

MY OLD COLLEAGUE FREE GRID appears to be suffering from a bee in his bowler. Why, in view of that profound knowledge of the classics that he sometimes displays, he should imagine that ter- is the Latin prefix meaning threefold and tri- its Greek equivalent I don't know. The

truth is, of course, that tri- is common to both ancient tongues, as you may see in "triangle," which is pure Latin, and in the "trigon" of trigonometry which is equally pure Greek for the same thing. If Free Grid really wants to rechristen all the multiples and submultiples of our electrical units on the index system why doesn't he adopt the method invented by (I think) Johnstone Stoney? Johnstone Stoney called 4.5×10^{-8} m four point five eighththet metres. On those lines a microfarad would become a sixthet farad and a picofarad a twelfthet farad. So far as I remember, the plain ordinals were used for numbers with positive indices, which would make the kilocycle into a third cycle and the megohm into a sixth ohm. The trouble about such a system is that it would not be international. As the metric system is so firmly established, it's not likely to be ousted and we shall go on using deka-, hecto-, kilo- and mega- for the multiples of units and the Latin deci-, centi-, milli-, for the submultiples. Mega-, micro- and pico- also seem to have come to stay. The real bother is that nowadays we want to go many steps further upwards than the 10^6 of mega- and many further down than the 10^{-12} of pico-.

MANUFACTURERS' LITERATURE

Illustrated leaflet describing neon indicator lamps, from Acru Electric Tool Manufacturing Co., 123, Hyde Road, Ardwick, Manchester, 12.

Catalogue of valves for industrial, medical and special applications, from the Edison Swan Electric Co., 155, Charing Cross Road, London, W.C.2.

The following additions have been made to the illustrated leaflets issued by Marconi's Wireless Telegraph Co., Chelmsford: "Marconi Broadcasting" (Ref. SP12), "V.H.F. Direction Finder" (Ref. SL34) and "Type ACPT8 Transmitting Valve" (Ref. B41).

Illustrated leaflet describing the "Universal Dial and Drive System" made by the Plessey Company, Ilford, Essex.

List of A.C. and D.C. solenoids made by Westool, Ltd., St. Helen's Auckland, Bishop Auckland, Durham.

Leaflets describing Type P4 I.R. transformers and Series B coil packs made by Weymouth Radio Manufacturing Co., Crescent Street, Weymouth.

INDICATORS -

BULGIN

REGISTERED TRADE MARK

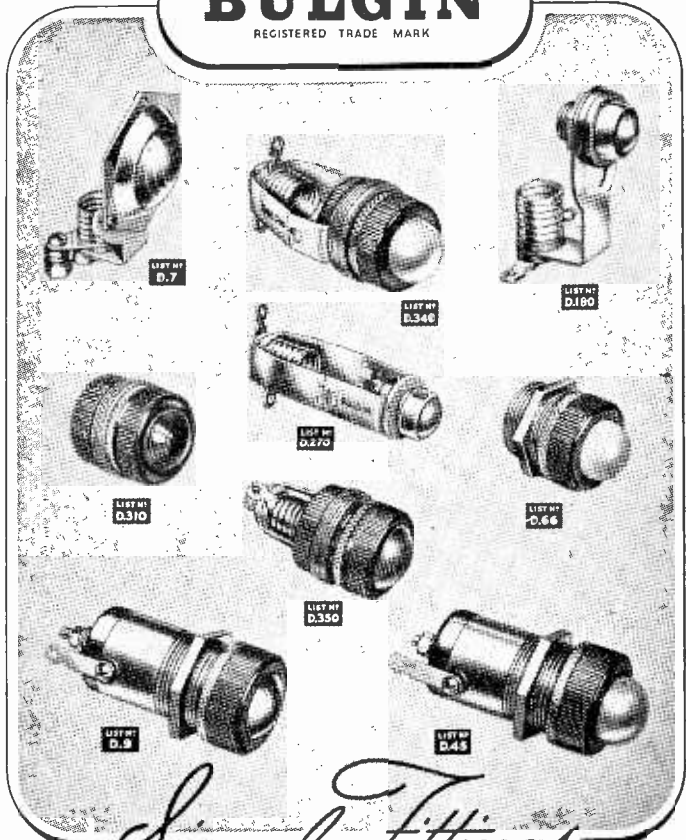

Signal Fittings

IN ALL COLOURS

Universally used by reason of their complete reliability, these signal fittings are found on all types of electronic and domestic electrical apparatus. The types illustrated are for low-voltage use, and are designed for M.E.S.-cap and similar lamp bulbs. Models are available with one pole to "live" frame, or with frame "dead" (when max. [peak] wkg. V. to E. = 250, 500 V. peak test). Internal lamp-holding arrangements ensure permanent trouble-free contacting. Types also manufactured suitable for M.B.C. and S.E.S lamps.

Enquiries for direct—and indirect—export are particularly invited.

BULGIN

REGISTERED TRADE MARK

"The Choice

of Critics"

A. F. BULGIN & CO. LTD. · BYE-PASS RD. · BARKING.

Telephone : RIPPleway 3474 (5 lines)

RECENT INVENTIONS

A Selection of the More Interesting Radio Developments

DIRECTIONAL F.M. SYSTEMS

IN directional systems where the critical changes in signal strength are caused by changes in the amplitude of the carrier, due to the relative orientation of receiver and transmitter, it is not possible to use frequency-modulated signals alone, because the strength of such signals is independent of wave amplitude, and would therefore be the same for all directions in space.

According to the invention, the difficulty is overcome by introducing an auxiliary phase modulation between the transmitter and receiver, from which the desired directional information is derived. In its simplest form a spaced arrangement of aerials is used, either at the transmitter or receiver, and these are successively switched into circuit in cyclic order, thereby imposing a phase sweep which depends upon the relative orientation of the spaced aerials, and is therefore a function of changing direction.

The use of frequency modulation permits several different beacons to be operated on the same carrier, so that each dominates a given area. It also simplifies the problem of eliminating interference.

Standard Telephones & Cables, Ltd.; C. W. Earp; and C. E. Strong. Application date, August 4th, 1944. No. 594530.

TELEVISION

IN transmission, the audible signals included in a television programme take the form of an intermittent sequence of frequency-modulated elements of the carrier wave on which the picture and synchronizing signals are imposed as amplitude modulations. The F.M. signals are timed to follow the synchronizing impulses in the otherwise idle flyback period of each of the scanning lines, so that they are sufficiently close-set to preserve apparent continuity. An auxiliary pulse generator, linked to the saw-toothed scanning control, serves in combination with a delay circuit to pass the sound signals at the proper intervals to a common mixing valve.

In reception, the picture signals are separated from the synchronizing signals in known manner. The input also includes a branch circuit with a selector or gate valve which is controlled from the local scanning oscillator so that, at the proper instants, it can pass the sound signals through to

a frequency-discriminating circuit, where they are first converted into equivalent amplitude modulations and then fed to the loudspeaker.

Marconi's Wireless Telegraph Co., Ltd. (assignees of G. L. Fredendall and A. C. Schroeder). Convention date (U.S.A.), March 24th, 1944. No. 595730.

PULSE-MODULATING CIRCUITS

A PASSIVE network of inductance and capacitance is used to superpose speech or other signals on a train of pulses, normally of equal spacing.

The modulating circuit M includes a series of iron-cored inductances shunted by condensers. It is fed with pulses of constant repetition frequency from a source S, and simultaneously with signals from a microphone amplifier A. The fluctuating signal current varies

less the latter are tuned to a high degree of accuracy.

According to the invention, frequency-modulated signals are used both for interrogation and response. It is then found that any phase-shift that may occur in the tuned circuits is without effect on the relative phase of the demodulated signals and so does not impair the accuracy of the distance indicator.

Bendix Aviation Corp. Convention date (U.S.A.), October 15th, 1942. No. 587773.

TWO-WAY SIGNALLING

SIGNALS are sent from point to point, in both directions, by amplitude-modulating two interlaced trains of pulses, both on the same carrier wave, so that no change-over

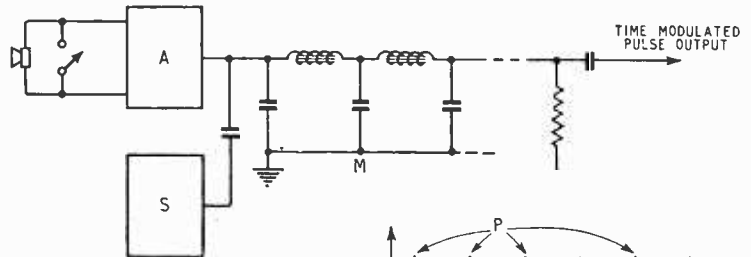

Pulse-modulating network.

the permeability of the inductance cores, and so alters the retardation curve of the network.

In the diagram showing the resulting time modulation of the pulses, P represents their original spacing, and P1 the relative displacements produced under the influence of an audio signal V. The system is particularly suitable for multiplex signalling, because the time displacements are small enough to permit the use of a relatively large number of separate channels.

Standard Telephones & Cables, Ltd. (assignees of E. Labin). Convention date (U.S.A.), July 24th, 1944. No. 593101.

F.M. INTERROGATOR-RESPONDER

IN a known method of measuring distances, an amplitude-modulated interrogating signal is radiated from one station and automatically triggers a similar response signal from a distant station, which radiates on a carrier wave of different frequency. The response signal is rectified at the calling station, and the distance between the two stations is then indicated by the phase difference between the two low-frequency signal components. In practice, it is found that serious errors can occur, owing to the phase-shift of the modulation envelope that is liable to take place in the receiving circuits, un-

switch is required for sending and receiving.

Each of the stations is provided with a pulse generator which is coupled to the local transmitter through a gate valve, so that transmission from that station occurs only during the positive half-cycle of each pulse. The local receiver is then automatically muted, but is made operative during each of the negative half-cycles.

The pulse generators at the two stations are interlocked in such a way that the cessation of the first pulse received from the distant station triggers a response pulse from the local station; and so on, until the two stations are connected by two interlaced trains of pulses, both having a repetition frequency determined by the transit time between the stations, plus the time constant of the local generator. The modulating signal is not allowed at any time to reduce the pulse amplitude to zero.

Ace Electronics, Ltd.; L. C. Welch, and R. J. Cook. Application date, April 5th, 1945. No. 591968.

The British abstracts published here are prepared with the permission of the Controller of H.M. Stationery Office, from specifications obtainable at the Patent Office, 25, Southampton Buildings, London, W.C.2, price 1/- each.